

FEMEI ȘI BĂRBAȚI ÎN REPUBLICA MOLDOVA

WOMEN & MEN
IN THE REPUBLIC OF MOLDOVA



WOMEN AND MEN IN THE REPUBLIC OF MOLDOVA

STATISTICAL COMPILATION

This compilation was commissioned by the United Nations Development Fund for Women within the UNDP, UNIFEM & UNFPA Joint Project on Strengthening National Statistical System with the financial support of Swedish International Development Cooperation Agency (Sida).



UNIFEM is the women's fund at the United Nations. It provides financial and technical assistance to innovative programmes and strategies that promote women's human rights, political participation and economic security. UNIFEM works in partnership with UN organisations, governments and nongovernmental organisations (NGOs) and networks to promote gender equality. It links women's issues and concerns to national, regional and global agendas by fostering collaboration and providing technical expertise on gender mainstreaming and women's empowerment strategies.

Editorial Board of the National Bureau of Statistics:

Vladimir Golovatiuc – Chairman of the Board

Nina Cesnocova

Elena Vâtcărău

Elena Basarab

Ala Negruța

Liuba Stoianov

Jana Mazur

Maria Vasiliev

Larisa Chirița

Consultant (including indicators' analysis):

Cristina Vaileanu

The views expressed in this publication do not necessarily represent those of the institutions of the United Nations.

Women and Men in the Republic of Moldova – 4th Edition – Chișinău, 2008, 300 p.

Copies: 1000

ISBN 978-9975-66-116-4

CZU 316.346.2(478)(083.41)

F 35

Design: Publishing house "Elan Inc", Republic of Moldova, Chisinau, 7, Mesager str., Tel.: (373 22) 74-57-71

Print: SC "Elan Poligraf" SRL, Republic of Moldova, Chisinau, 7, Mesager str., Tel.: (373 22) 74-58-00

National Bureau of Statistics
of the Republic of Moldova, 2008
106, Grenoble str., Chișinău
Tel. +373 22 40 30 00, Fax +373 22 22 61 46
E-mail <http://www.statistica.gov.md>

CONTENTS

I. Gender statistics	161
II. International and national tools for gender statistics improvement	162
III. Reader's guide	164
IV. Background	165
1. PARTICIPATION OF WOMEN IN THE PUBLIC AND POLITICAL LIFE	173
1.1. Participation in the central power structures, as of 14.04. 2008	173
1.2. The number of the members of the Parliament by faction and parliamentary political parties, as of 14.04.2008	173
1.3. The structure of the leading staff of the ministers and central public administration bodies, as of 14.04.2008	174
1.4. Number of women working in law-enforcement bodies, as of 14.04.2008	175
1.5. Participation in local power structures, as of 14.04.2008	175
1.6. Elected persons and staff of the local public administration, as of 14.04.2008	176
2. POPULATION	177
2.1. Number of women and men as of 01.01.2008	177
2.2. Number of population by some age groups, as of 01.01.2007	178
2.3. Number of population in territorial aspect, as of 01.01.2008	178
2.4. Population structure by some age groups in territorial aspect, as of 01.01.2008	179
2.5. Population ageing coefficient, 2006-2007	180
2.6. Population ageing coefficient by area of residence in 2003-2007	180
2.7. Life expectancy at birth and certain ages, 2006-2007	181
3. NATURAL MOVEMENT OF POPULATION	182
Birth rate	182
3.1. Number of live births, 2006-2007	182
3.2. Live births outside marriage by area of residence in 2003-2007, in %	182
3.3. Live births by mother's age group in 2003-2007	182
3.4. Live births by mother's age group by area of residence in 2007, in %	183
3.5. Distribution of live births by newborn's rank, 2006-2007	183
3.6. Distribution of live births by newborn's rank by area of residence in 2007, in %	184
3.7. Number of live births in territorial aspect, in 2007	184
3.8. Number of live births outside marriage in territorial aspect, 2006-2007	185
Fertility	186
3.9. Female fertility by age group, 2006-2007	186
3.10. Total fertility rate by area of residence for 2003-2007	186
3.11. Pregnancy interruptions by type and age group, 2006-2007	186
3.12. Use of contraception means, 2006-2007	187
General mortality	187
3.13. General mortality rates by age group, 2006-2007	187
3.14. Mortality rates by age and sex in 2007	188
3.15. Deceased by main causes of death, 2006-2007	188
3.16. Deceased by main causes of death in 2007	188
3.17. Mortality as a result of female and male genital cancer, 2006-2007	189
3.18. Mortality as a result of female and male genital cancer, 2003-2007	189
3.19. Deceased persons of working age by main death cause, 2006-2007	190
3.20. Mortality as a result of homicide, 2006-2007	190
3.21. Structure of mortality as a result of homicide, by sex, 2003-2007, in %	190
3.22. Mortality as a result of suicide, 2006-2007	191

3.23. Number of suicides by sex and age, 2007	191
3.24. Number of deceased in territorial aspect, 2007	191
Maternal mortality and mortality in children of 0-4 years old	192
3.25. Maternal mortality, 2006-2007	192
3.26. Maternal mortality by area of residence, 2003-2007	192
3.27. Infant mortality, 2006-2007	193
3.28. Infant mortality rate by area of residence, 2003-2007	193
3.29. Infant mortality by death causes, 2006-2007	194
3.30. Deceased under 1 year of age, by main death causes, 2003-2007	194
3.31. Child mortality in age group 0 – 4 years old by death cause, 2006-2007	194
3.32. Mortality rate in children of 0-4 years old by area of residence, in 2003-2007	195
Marriages and divorces	195
3.33. Marriages and divorces, 2006-2007	195
3.34. Marriage and divorce rates, in 2003-2007	195
3.35. Marriages by the age of spouses, 2006-2007	196
3.36. Marriages by age and previous civil status of spouses in 2007	196
3.37. Marriages by age and previous civil status of spouses in 2007, in %	196
3.38. Share of first marriages in the age group 15-19 years old in the total of marriages concluded for the first time, 2006-2007	197
3.39. Share of first marriages in the age group of 15-19 years old in the total of marriages concluded for the first time by area of residence, 2003-2007	197
3.40. Marriages by age group of spouses in 2007	197
3.41. Marriages concluded by the nationality of spouses, in 2007	198
3.42. Marriages by the number of marriages concluded, 2006-2007	198
3.43. Divorces by the nationality of spouses, 2006-2007	199
3.44. Divorces by duration of marriage and age group in 2007	199
3.45. Divorces by the number of broken marriages, 2006-2007	199
3.46. Divorces by the number of common children in territorial aspect in 2007	200
4. HEALTH	201
Morbidity by active tuberculosis	201
4.1. Morbidity by active tuberculosis, 2003-2007	201
4.2. Morbidity through active tuberculosis by area of residence, 2006-2007	201
4.3. Morbidity through active tuberculosis by age group, 2006-2007	202
4.4. Morbidity through active tuberculosis by age group, 2007	202
Malignant tumour morbidity	202
4.5. Malignant tumours morbidity, 2003-2007	202
4.6. Malignant tumours morbidity by age group and localization, 2006-2007	203
4.7. Malignant tumours morbidity by age group, 2006-2007	203
4.8. Malignant tumours morbidity specific to women, by age group, 2006-2007	203
4.9. Malignant tumours morbidity specific to men, by age group, 2006-2007	204
Alcoholic disorders	204
4.10. Alcoholic disorders morbidity, 2003-2007	204
4.11. Alcoholic disorders morbidity, 2006-2007	204
Morbidity by infectious sexually transmitted diseases	205
4.12. Morbidity of patients depending on the infections transmitted mainly sexually, by area of residence, 2006-2007	205
4.13. Distribution of infected persons depending on the infections transmitted mainly sexually, by sex and age, 2006-2007	205
4.14. Gonorrhoea morbidity, 2003-2007	206
4.15. Syphilis morbidity, 2003-2007	206

4.16. Syphilis morbidity by age group, 2007	206
4.17. Gonorrhoea morbidity by age group, 2007	207
Carriers of the Human Immunodeficiency Virus	207
4.18. Carriers of human immunodeficiency virus (HIV) by sex and age group, 2006-2007	207
4.19. Carriers of human immunodeficiency virus (HIV) who developed AIDS disease, by sex and age group, 2006-2007	208
4.20. Carriers of human immunodeficiency virus (HIV), 2003-2007	208
Health status of women in prenatal period	208
4.21. Health status of pregnant women, parturients and women after childbirth, 2006-2007	208
4.22. Number of pregnant women and deliveries in time, 2003-2007	209
4.23. Doctors by category and sex, 2006-2007	210
Disabled persons	210
4.24. Distribution of persons aged 16 and over, recognized as disabled for the first time by sex, age group and area of residence, 2006-2007	210
4.25. Number of persons recognized as disabled for the first time by sex, 2003-2007	210
4.26. Share of persons recognized as disabled for the first time per 1000 persons of respective age group, in 2007	211
Health status estimation	211
4.27. Health status estimation by sex, 2007	211
4.28. Health status estimation by sex and age group, 2007	212
Smokers	212
4.29. Share of people smoking daily or occasionally by age group and sex, 2005	212
4.30. Share of people who never smoked by age group and sex, 2005	212
4.31. Structure of smoking population aged 15 and over, by the age they began smoking, by sex and age groups, 2005	213
Obesity	213
4.32. Share of obese people by age group and sex, 2005 ¹	213
4.33. Structure of population aged 18 and over according to Body Mass Index, by sex and age group, 2005 ²	214
Alcohol Consumption, 2005	215
4.34. Structure of male population by the frequency of alcohol consumption, %	215
4.35. Structure of female population by the frequency of alcohol consumption, %	215
4.36. Structure of population aged 15 and over by the frequency of alcohol consumption during the last 12 months, by sex and age groups, %, 2005	215
5. INTERNATIONAL MIGRATION	217
5.1. Number of emigrants and immigrants, 2006-2007	217
5.2. Emigrants by destination country, 2006-2007	217
5.3. Emigrants by age group, 2006-2007	217
5.4. Emigrants by age group, in 2007	218
5.5. Emigrants by level of education, 2006-2007	218
5.6. Characteristics of immigrants by the purpose of their arrival in the country of emigration, 2006-2007	219
5.7. Immigrants by nationality, 2006-2007	219
5.8. Structure of refugees by sex and age group at the end of 2007	219
5.9. Distribution of refugees by country of origin, at the end of 2007	219
5.10. Distribution of asylum seekers by sex and age group, at the end of 2007	219
6. LABOUR MARKET	220
Labour Force	220
6.1. Distribution of population aged 15 and over, by its participation in the economic activity, 2006-2007, th.persons	220
6.3. Economically active population by age group, 2006-2007	222

6.4. Population of 20-49 years old by its participation in the economic activity, number of pre-school aged children, by sex and area of residence, in 2007	222
Employment	222
6.5. Employed population by age group, 2006-2007	222
6.6. Employment rate by age group, 2006-2007	223
6.7. Employed population by education level, 2006-2007	223
6.8. Employment rate by level of education, 2006-2007	224
6.9. Employed population by economic activity, 2006-2007	225
6.10. Employed population by occupation group, 2006-2007	226
6.11. Employed population by professional status, 2006-2007	226
6.12. Employed population by ownership form, 2006-2007	227
6.13. Employed population by type of production unit, 2006-2007	227
6.14. Employed population by type of occupation, 2006-2007	228
6.15. Number of employees by economic activity, 2006-2007	228
6.16. Number of employees in agriculture and industry, 2006-2007	229
6.17. Number of employees by location, 2006-2007	230
6.18. Vocational training of employees, 2006-2007	231
Unemployment	231
6.19. ILO unemployed by age group, 2006-2007	231
6.20. ILO unemployment rate by age group, 2006-2007	232
6.21. ILO unemployed persons by education, 2006-2007	233
6.22. ILO unemployed rate by education level, 2006-2007	233
6.23. ILO unemployed by length of unemployment, 2006-2007	234
6.24. The long-term unemployment rate by age group, 2006-2007	234
6.25. Unemployment among young people aged 15-24 years, 2006-2007	235
6.26. Unemployed registered at employment agencies by age group, 2006-2007	235
6.27. Unemployed registered by employment agencies, by level of education, 2006-2007	236
6.28. Vocational training of registered unemployed, 2006-2007	236
Working conditions	237
6.29. Harmful and dangerous factors ¹ to which employees are exposed, 2006-2007	237
6.30. Working conditions of employees by economic activity in 2007	237
6.31. Facilities and supplements granted to employees for unfavourable working conditions by economic activity in 2007	238
6.32. Labour accidents by economic activity, 2006-2007	239
Labour remuneration	239
6.33. Average salary in September by economic activity, 2006-2007	239
6.34. Average salary in September by location, 2006-2007	240
6.35. Average monthly salary by some positions/professions and activities in October, 2006-2007	241
7. EDUCATION	244
General background	244
7.1 Students by type of institution, 2006/2007, 2007/2008	244
7.2. Teaching personnel by type of institution, 2006/2007, 2007/2008	244
7.3 Share of female teachers in the total number of teaching staff in 2007/2008	244
7.4. Enrolment rate by educational level, %	245
Preschool education	245
7.5. Number of children in preschool institutions, by area of residence, 2006-2007	245
7.6. Number of children in preschool institutions, by sex, 2003-2007	245
7.7. Preschool institutions, by type and area of residence, 2007	246
7.8. Preschool institutions by type and area of residence, 2007	246
7.9. Preschool institutions, by location, 2006-2007	247

Primary and general secondary education	248
7.10. Students in day schools, gymnasiums and lyceums, by grade, 2006-2007	248
7.11. Students in day schools, gymnasiums, lyceums, by age group, 2006-2007	248
7.12. Graduates of day schools, gymnasiums, lyceums, 2006-2007	249
7.13. Teaching staff in day schools, gymnasiums, lyceums, 2003/2004-2007/2008	249
Vocational secondary and specialised secondary education	250
7.14. Graduates, enrolled, and number of students in vocational secondary institutions, by sex, 2006/2007-2007/2008	250
7.15. Students of vocational secondary education, by age and sex, 2006/2007-2007/2008	250
7.16. Teaching staff in vocational secondary education institutions, by sex	250
7.17. Teaching staff ratio in vocational secondary institutions, by sex, during education years 2003/2004 - 2007/2008	251
7.18. Graduates, enrolled, and number of students in colleges, by sex, 2006/2007-2007/2008	251
7.19. Students in colleges, by branch group and sex, 2006/2007-2007/2008	251
7.20. Proportion of students in colleges, by branch group and sex, in education year 2007/2008	252
7.21. Students in colleges, by age and sex, 2006/2007-2007/2008	252
7.22. Teaching staff in colleges, by sex, during 2003/2004 - 2007/2008 school years	252
Higher education	253
7.23. Graduates, enrolled, and number of students in higher education institutions, by sex	253
7.24. Graduates, enrolled, and number of students in higher education institutions, by type of education and sex, 2006/2007-2007/2008	253
7.25. Students in higher education institutions, by branch group and sex, 2006/2007-2007/2008	253
7.26. Proportion of students in higher education institutions, by branch group and sex in 2007/2008	254
7.27. Students in higher education institutions , by age and sex, 2006/2007-2007/2008	254
7.28. Scientific research and teaching staff in higher education institutions, 2006/2007-2007/2008	254
7.29. Proportion of teaching-scientific personnel in higher education institutions, by sex, in education years 2003/2004- 2007/2008	255
Doctorate and Post-Doctorate	255
7.30. Post-graduate education (doctoral students), 2006-2007	255
7.31. Doctoral students, by age and sex, 2006-2007	256
7.32. Post-doctoral student's education, 2006-2007	256
7.33. Research doctors in the research and development activity (without part-timers), 2003-2007	256
7.34. Research doctors habilitat in the research-development activity (without part-timers), 2003-2007	257
8. SOCIAL PROTECTION	258
Pensions	258
8.1. Number of pensioners by sex and category of retirement, 2006-2007	258
8.2. Pensioners' share in total population, by sex, 2003-2007	258
8.3. Number of old-age pensioners, by sex and age group, 2006-2007	258
8.4. Number of disability pensioners, by sex and age group, 2006-2007	259
8.5. Number of disability pensioners by grade of disability, cause and sex , 2006-2007	259
8.6. Share of disability pensioners in total pensioners, by sex, at 1 January 2004-2007	259
8.7. Number of disability pensioners, by age group and sex, 2006-2007	260
8.8. Average size of old-age pension by sex, at 1 January 2002-2007	260
8.9. Ratio between the average old-age pension and the average salary in the economy, at 1 October, 2002-2007	261
8.10. Average old-age pension by sex, age group and area of residence, at 1 January	261
8.11. Number of old-age pensioners and average pensions by economic sector, 2006-2007	261
8.12. Share of pension expenditure in the GDP, 2003-2007	263
Social Securities	263
8.13. Number of persons contributing to the social security system, 2006-2007	263
8.14. Number of persons on child care leave by sex, 2006-2007	263

8.15. Share of women on maternity leave in the total number of women of fertile age, 2004-2006	264
8.16. Average size of child allowances, 2003-2007	264
8.17. Ratio between child allowances and subsistence minimum for children, 2003-2007	264
8.18. Expenditures of the state social insurance budget, 2003-2007	265
8.19. Boarding houses for elderly and disabled, 2003-2007	265
8.20. Placement of children and adolescents left without parental care, 2003-2007	265
9. CRIMINALITY	266
Persons who committed offences	266
9.1. Persons who committed offences, 2003-2007	266
9.2. Persons who committed offences per 100 thousand persons, 2003-2007	266
9.3. Minors who committed offences per 100 thousand personsv	266
9.4. Persons who committed offences, by main type of offences, by sex and area of residence, 2006-2007	267
9.5. Persons who committed offences per 100 thousand persons, by area of residence, 2006-2007	268
9.6. Minors who committed offences, by main type of offences, by sex and area of residence, 2006-2007	268
9.7. Minors who committed offences per 100 thousand minors, by area of residence, 2006-2007	269
9.8. Persons who committed offences, by age group, sex and area of residence, 2006-2007	269
9.9. Women who committed offences, by age group in 2006-2007	270
9.10. Men who committed offences, by age group in 2006-2007	270
9.11. Persons who committed offences, by main type of offences, age group and area of residence, 2006-2007	270
Convicted persons	271
9.12. Convicted persons, 2006-2007	271
9.13. Convicted persons, by type of punishments administered by courts, by area of residence of convicted person, 2006-2007	271
9.14. Distribution of convicted women, by punishment, 2006-2007	271
9.15. Convicted men, by punishment, 2006-2007	272
9.16. Convicted persons by type of crime	272
9.17. Distribution of convicted women, by committed offence, in 2006-2007	273
9.18. Convicted men, by committed offence, in 2006-2007	273
Persons detained in penitentiaries	273
9.19. Number of detainees in penitentiaries, 2003-2007	273
9.20. Number of detainees in penitentiaries, 2003-2007	274
9.21. Distribution of detainees in penitentiaries per 100 thousand persons, 2003-2007	274
9.22. Number of convicted persons in penitentiaries, 2003-2007	274
9.23. Number of convicted persons in penitentiaries, 2003-2007	274
9.24. Convicted persons in penitentiaries, by sex and age group, 2006-2007	275
9.25. Women in penitentiaries, by age group in 2006-2007	275
9.26. Men in penitentiaries, b0079 age group in 2006-2007	276
9.27. Foreign detainees in penitentiaries, by sex, 2006-2007	276
Trafficked Persons	276
9.28. Trafficked persons, 2006-2007	276
9.29. Trafficked persons, 2006-2007	276
9.30. Trafficked minors, 2006-2007	277
9.31. Number of trafficked persons by age group, 2006-2007	279
Road accidents	279
9.33. Persons who suffered as a result of road accidents, 2006-2007	279
9.34. Persons who suffered as a result of road accidents, 2006-2007	279
10. LIVING STANDARDS	280
10.1. Main characteristics of households by sex of household head, 2006-2007	280
10.2. Distribution of household members aged 15 and over by main source of income and sex, 2006-2007	281

10.3. Distribution of household members aged 15 and over by main source of income and age group, 2006-2007	281
10.4. Structure of disposable income by sex of household head, 2006-2007	282
10.5. Structure of consumption expenditures by sex of household head, 2006-2007	283
10.6. Provision of households with amenities, by area, 2006-2007	284
10.7. Provision of households with durable goods, by area, 2006-2007	284
10.8. Assessment of the standard of living, by area, 2006-2007	285
10.9. Poverty rate, by area of residence and household size, 2006-2007	285
10.10. Poverty rate by type of household, 2006-2007	286
11. INTERNATIONAL STATISTICS	287
11.1. Population by selected age groups (% of total), 2005	287
11.2. Live births by sex (% of total), 2005	287
11.3 Infant mortality rate, 2005	288
11.4. Infant mortality rate, 2005	288
11.5. Mortality rate for children aged 1-4 years, 2005	288
11.6. Total fertility rate, 2005-2006	289
11.7. Life expectancy at birth, 2005	289
11.8. Life expectancy at birth by sex, 2005	289
11.9. Percentage of women in national parliaments, 2007	290
11.10. Labour force participation rate in some selected countries, 2005-2006	290
11.11. Employment rate in some selected countries, 2005-2006	290
11.12. Unemployment rate in some selected countries, 2005-2006	291
Glossary of terms	292

I. GENDER STATISTICS

Women and men should be “visible” in any type of statistics. Gender statistics should present the place and role of women and men in a society, taking into consideration the peculiarities of both women and men as social-demographic groups, as well as the different social-economic realities women and men from a society should face.

Gender statistics comprises statistical data reflecting the reality of women and men lives in all life’s spheres, including the realities between sexes. As a result, gender statistics shows gender equality existent at the level of a society by making visible the conditions and experiences of women and men in all the phases of their life cycle. Gender statistics has as an objective to offer an unbiased basis for the comparison and evaluation of progresses made in achieving gender equality and women situation improvement.

GENDER STATISTICS

1. All statistical data referring to people shall be collected, centralized and presented broken down by sex;
2. All the variables and characteristics should be analyzed and presented, having as a primary and general criterion the sex criterion ;
3. Special efforts should be done to identify gender problems and to ensure collection of data regarding these issues and their public dissemination.

Gender statistics does not mean only generation of statistical data regarding women. It is more than a simple break-down of statistical data by sex. A statistics generation that would adequately reflect gender aspects implies that all statistics shall be produced taking into account the different social-economical realities between women and men at the society level. This means that all the statistical data (both data referring to individuals and those unrelated directly to individuals) should be collected, compiled, taking into account gender factors that influence women and men differently. We could call this as gender mainstreaming in statistics¹.

Those who generate gender statistics depend on the requirement of new types of data coming from the users of statistical data broken down by sex, depending on the needs they have. The users need knowledge about the statistics and gender indicators in order to be able to ask for statistical data broken down by sex and to know how to use them efficiently. At the same time, work with gender statistics requires experience and skills in the field of gender equality and gender analysis. In this context, it is very important to underline the interaction between those producing gender statistics and data broken down by sex and actual and potential users of these statistical data.

In this context, there occur some questions to which the users of gender statistics should answer:

- What fields should be studied?
- Which is the necessary detail level?
- Is there any field that needs to be developed?
- Are there any fields of interest for which no statistical data are collected?

By the help of this booklet, we invite you, the readers, to ask yourselves these questions. Similarly, it is important that statistical data users have a clearer idea concerning the opportunities the statistics offer and also concerning their limitations.

¹ In English “Gender mainstreaming in statistics”

II. INTERNATIONAL AND NATIONAL TOOLS FOR GENDER STATISTICS IMPROVEMENT

Gender equality is a key policy objective which became more and more important during the last years. Because it is included in those eight Millennium Development Goals (MDGs) it receives a special attention when the progresses and developments in the field are discussed.

Gender equality is seen more and more as having a double importance: realization of a fundamental right and stimulation of the economic growth. These two aspects are strongly correlated: policy-makers begin to recognize that women discrimination has higher and higher economic and social costs, while gender equality contributes to the stimulation of economic growth. Together with the increased interest on gender equality the increases also the emphasis put on the measuring modalities for gender equalities and, as a result, on the development of gender statistics and composite indicators² of gender equality.

Statistics and gender indicators are essential elements in defining targets and monitoring the progress registered in realization of gender equality, as well as in achievement of larger objectives for a society development. Moreover, registering some positive results in the realization of gender equality depends not only on the availability of gender statistics, but also on the efficient use of statistics in formulation, monitoring and evaluation of policies, as well as in management of the results of the analysis of these statistics – respectively, the adoption of some measures/policies for correction of gender inequality and equality promotion.

Nevertheless, in many states women remain to be a resource not used at its real efficiency: their participation in the labour force is restricted by the traditional mentality, horizontal and vertical segregation existing at the labour market level, discrimination in remuneration or difficulties of reconciliation between professional life and family life.

Gender inequalities still continue in the Republic of Moldova. Further, although women represent more than half of the population of the country, they have a representation of only 22% in the Parliament. Although women are more educated than men, on average, they earn approximately 30% less than men. There is a horizontal and vertical segregation of the labour market against women, which perpetuates and forms even in school: women work in the budgetary field which is less paid, like health and social assistance, education; at the same time more men compared to women hold leading positions, better paid. Rather women than men interrupt their paid work to take care of children and other family members and this means that their incomes decrease and create them a financial dependency on their husband /partner. Women live on average 8 years more than men, however the most often the quality of their longer lives becomes worse and the of poverty is higher than in the case of men.

All these phenomena have to be adequately solved by the help of public policies. However, in order to develop public policies and action plans that would promote gender equality and monitor the progress achieved in this field, it is essential that correct statistical data would be in place and these data should reflect the reality of women and men lives in a society. This need has been identified and addressed at the international level first of all by the United Nations.

In this sense, the Beijing Platform for Action, adopted on the occasion of the fourth World Conference on Women Status in 1995 recognises the need for a gender analysis and gender mainstreaming in policy development and programme implementation. Also, it calls upon the governments and international institutions to promote research and information dissemination in certain important fields, expressing the need for statistics that would monitor achievement of objectives and strategies in the key fields.

Of course that European Union is as well concerned constantly about the development and dissemination of gender statistics. With the Framework Strategy for Gender Equality 2001-2005³ the European Commission started to put a stronger accent on the need of gender statistics development. The main interest

² UNDP has developed Gender-related Development Index – GDI and Gender Empowerment Measure – GEM; Gender Gap Index, suggested in 2006 by the World Economic Forum; Gender Equity Index developed by Social Watch in 2005. Also in 2005, the African Gender and Development Centre introduced a regional indicator for measuring gender equity – the African Gender and Development Index – AGDI, and in March, 2006, the OECD Development Centre introduced Gender, Institutions and Development Data Base - GID-DB).

³ COM(2000) 335 final, <http://eur-lex.europa.eu/LexUriServ/LexUriServ.do?uri=COM:2000:0335:FIN:EN:PDF>

points refer to development and dissemination of statistical data broken down by sex, comparable, for different fields of public policies, as well as for the development of methodologies and indicators for European policies and practices evaluation from gender perspective.

At the national level, the Republic of Moldova has signed in 2000 the Millennium Declaration and in the same year the UN Committee for elimination of discrimination towards women, during the 23rd session submitted a list of recommendations as a result of the National Report evaluation. Among these recommendations it was also included the recommendation to adopt a law on equality of opportunities, development of a national strategy that would promote equality between men and women in all fields, and last but not least, gender statistics development.

In February, 2006 the Law on ensuring equality of chances between women and men was adopted and then the National Plan "Promoting Equality of Human Genders in Society for the Period 2006-2009", approved by the Government Decision of the Republic of Moldova no. 984 of 25.08.2006. In both documents there are specific referrals to gender statistics development:

Article 22 of the Law on equality of chances between women and men stipulates that the National Bureau of Statistics has the responsibility to collect, process and generalize statistical information broken down by sex and that central and local public administration bodies, parties, other social-political organizations, legal entities and physical entities carrying out entrepreneurial activity have the obligation to present the necessary information broken down by sex to the National Bureau of Statistics.

The specific objective No. 3 from the National Plan refers to the improvement of gender statistics and collection of data, broken down by sex.

However, in August, 2006⁴ the comments of the Committee on the Elimination of Discrimination Against Women refers to the limited availability of statistical data, classified according to the criteria of sex, ethnic affiliation and age, urban area and rural area, fact that complicates the evaluation of the progress and the dynamics of trends, regarding to actual situation of women and their exercising of human rights in all the fields the Convention covers in order to eliminate discrimination against women.

In this sense, it is recommended to improve collection of data classified according to the criteria of sex, ethnic affiliation and age, urban area and rural area in all the fields covered by CEDAW. Also, Moldova is required to monitor the impact of laws, policies and action plans in quantifiable indicators and to evaluate the progress gender equality realisation. As a result, the Republic of Moldova should include such statistical data and analyses in the next report.

By this booklet we try to offer more statistical data and their short analyses that would sketch out the basis for future reports to CEDAW Committee, as well as a good working tool for the decision-makers to formulate a policy of redressing gender inequality and to help to develop some fair policies both for women and men.

⁴ The Committee examined the unified periodical reports no 2 and 3 of the Republic of Moldova (CEDAW C/MDA/2-3) at its 749 and 750 meetings, on 16 August, 2006 (see CEDAW /C/SR. 749 and 750). The list of issues and questions of the Committee could be found at CEDAW/C/MDA/Q/2, and answers of the Republic of Moldova – at CEDAW/C/MDA/Q/2/Add. 1

III. READER'S GUIDE

The statistical collection "Women and Men in the Republic of Moldova" is at its fourth edition, its development starting to be established on a biannual tradition. However, unlike previous editions, the edition of this year is a premiere from two points of view:

- the statistical data and the big groups in which they are presented represent the result of a process of consultation with the users of statistical data broken down by sex in order to address as closer as possible their needs regarding data;
- the statistical data are accompanied by short explanatory analyses which help users to form an overview on the situation of women and men and to understand better the dynamics of relations between sexes, progresses in realization of gender equality and gender inequalities existing within the society.

Statistical data originate mostly from diverse types of studies conducted by the National Bureau of Statistics of the Republic of Moldova, but also from other governmental institutions. A data source is offered for each table or diagram separately.

In most cases the tables and diagrams offer absolute figures, figures from 1.000 inhabitants and/or shares (percentage) for certain attributes/characteristics. The ratios are used in two ways:

- share (%) of women and share of (%) men with certain characteristics;
- distribution of sexes within a group.

Certain diagrams show both the absolute figures and distribution of sexes at the level of certain groups. Besides breaking-down data by sex, where possible, the statistical data offered in this statistical collection are broken down by rural/urban area of residence and age group. Also, depending on the relevance and the big category they are part of, data have been broken down by the level of education or field of economic activity.

IV. BACKGROUND

I. Participation of women in the public and political life:

Although women are still underrepresented at the level of the highest political structures, a series of improvements of this situation are noticed:

- it is for the first time the Republic of Moldova has a Government lead by a woman
- 29.4% is the share of women in the Cabinet
- the portfolio of public finances is lead by a woman
- women represent 21,8% of the Parliament members

On the other hand, there is a tendency that at the level of ministries and other central public administration bodies, even if there is a gender balance in the distribution of wage earners and even the decision taking positions, as advancing on the hierarchical scale of decision taking positions, the number of women decreases compared to the number of men: less than 20% women reach the level of Vice Minister/Vice Director and at the level of Minister/Director there are 26,7% women and 73,3% men.

At the level of local government, women representation seems to be worse: only 1 woman out of 32 persons is a rayon chairperson and only 17.5% women have been elected as mayors of municipality, town and village (communes).

II. Population

Women represent the majority of the population of the Republic of Moldova – 52% women and 48% men. At the beginning of 2008 there were 108 women to each 100 men.

On average, women live 7,5 years more than men.

Due to women's higher life expectancy and higher number of women compared to men at the population level, there are more aged women than men.

The highest coefficient for ageing population is among women from the rural area (18 women over 60 years old per 100 inhabitants compared to 12,2 men over 60 per 100 inhabitants).

Male population is a little bit younger. Working age persons represent 71% of female population and 73% of male population. However, the differences by gender are minimal as compared to those by area of residence. Share of working age population in urban area (77% of the total) is by 8 per-

centage points higher than in rural area. This is also reflected in the dependency rate, which represents 0,3 for the urban area and 0,45 for rural area.

During 2003-2007 population ageing coefficient remained relatively constant in urban area, while in rural area it decreased until 2006 and then increased in 2007 again at the level for 2003.

III. Natural movement of population

Demography:

More boys than girls are born every year: a share of 51,74% of the live births in 2007 were boys.

Generally, the majority of births take place within marriage, births outside marriage having a rate of about 20%. However, there are differences by area of residence, with higher shares of birth outside marriage in the rural area (between 24,4% and 25,9% during 2003-2007).

For more than half of the women of the Republic of Moldova who gave birth it was their first child and for a little bit more than 30% it was their second child. Women from rural area would rather give birth to more than two children than women from urban area (4,5% more women from rural area give birth to their third child and 3,2% - four children or more).

Since 2004, the total fertility rate in urban area started to decrease, from 1,135 in 2004 to 0,974 in 2007 (less than one child per woman of fertile age). In rural area, however, the total fertility rate increased from 1,301 in 2005 to 1,516 in 2007. This increase was, first of all, due to birth rate increase during that period, which was determined by the fact that generations born in 80's attained fertile age. In 80's birth rate reached the highest levels, especially in rural areas.

In 2007, the number of pregnancy interruptions slightly increased compared to 2006. More than 75% of pregnancy interruptions occurred in women from the age group of 20-34 years old. More than 30% of pregnancy interruptions during these two years were artificial, performed upon request. If in 2006 there were only 2 illegal pregnancy interruptions, than in 2007 their number increased approximately 6 times, reaching 11 illegal pregnancy interruptions.

Male mortality rates are higher than female mortality rates almost for all age groups. This determines differences related to other aspects, like: higher share of female population, higher ageing

rates in women. Also because of this, although more boys than girls are born, the share of men, as they get older, is continually decreasing, in the age group over 70 years old women representing 62,5%. On the other hand, this age group is the only one where female mortality rate is higher than male mortality rate.

In terms of death causes, the diseases of the circulatory system represent the main death cause both in case of women (64% of deaths) and men (approximately 49%). Actually, the diseases of the circulatory system represent the only death cause where the number of deaths in women is higher than in men, men prevailing numerically in any other cause of death. For example, as a result of accidents, intoxications and traumas three times more men than women die every year.

Although the mortality rate as a result of female genital cancer is almost double compared to the mortality rate because of male genital cancer, during 2003 – 2007, there is noticed a tendency of a slight decrease in female mortality rate and a slight increase in male mortality rate, both in urban and rural areas.

In 2006 and 2007 more than 85% of the total number of suicides were registered among men. The highest number of suicides in men occur in the age group 40-49 years old and 50-59 years.

During 2003-2007 maternal mortality rates in urban and rural areas inverted: if in 2003-2005 the maternal mortality rates in rural area were higher than in urban area, the biggest difference being in 2004 (33 women deceased per 100.000 live births in the rural area, compared to only 7,1 deaths in the urban area), in 2006 and 2007 maternal mortality rates in urban area were higher than in the rural area.

Infant mortality rate registers a slight decrease of the number of deceased children under 1 year of age in 2007 compared to 2006 in urban area, however, at the same time, we witness a slight increase of the number of children under 1 year of age deceased in the rural area. The mortality rate of children between 0-4 years old had a continuous decrease during 2003-2007, generally being higher in the rural area compared to urban area. An exception is 2006 when all the things inverted, however the difference was about 1,4 deceases per 1.000 live births.

Marriages and divorces

The number of marriages and also of divorces was higher in urban than in rural area: 9,9 marriages per 1000 inhabitants in urban area and 7 marriages per 1000 inhabitants in rural area and, respectively, 7,5 per 1000 inhabitants in urban area and 1,4 divorces per 1000 inhabitants in rural area.

Generally, women get married earlier than men – over 85% of people under 20 years married in 2007 are women.

In 2007, the most divorces occurred in marriages of 5-9 years, and quickly after, in marriages of over 20 years.

Most of divorcing women are in the age group of 20-29 years, whilst in the case of men the most of divorces occur in the age group of 30-39 years, which shows once again that the difference between spouses in of 5-10 years, in average.

The majority of divorces occur in family with one common child (over 69% of cases), once the number of children increases, the number of divorces decrease.

IV. Health

Tuberculosis:

Incidence of active tuberculosis in 2007 represented 201 new cases per 100 thousand population, being much higher in case of men (147 new cases) than in case of women (54 new cases). Tuberculosis morbidity rate is higher in rural area, 45% of the new morbidity cases registered in 2007 were from urban area, where only 39% of the population of the Republic of Moldova lives.

Tuberculosis morbidity risk is higher in people of average age (35 – 54 years old). At the same time women morbidity occurs at a younger age than in case of men.

Genital malignant tumours

In case of malignant tumours specific to women, a higher incidence is noticed in case of mammary gland morbidity – 743 cases in 2007 (52% from the total number of cases), followed by cervical tumours - 335 cases or 23%.

In case of tumours specific to men the highest number of diseases registered are the prostate tumours – 222 new cases or 87,75% from the total number. At the same time it is easy to notice that testicular tumours are registered preponderantly in the younger age groups, thus out of 18 morbidity cases in 2007 in 12 cases the sick person was in the age group of 20-39 years.

Alcoholism is a disease rather specific to men, in case of which the incidence for 2007 was of 2263 cases per 100 thousand population, being five times higher compared to its incidence among women (412 cases per 100 thousand population).

Sexually transmitted diseases

In 2007 there were registered approximately 22 thousand of new cases of morbidity by sexually transmitted infections, about 800 cases more, com-

pared to the previous year. Generally, the incidence of sexually transmitted diseases is noticed to be higher in urban area.

HIV/AIDS

In 2007 there were registered for the first time 418 HIV carriers, among which men represent the biggest share (239 or 57%).

The incidence of HIV infection among women, as compared to men, is higher in younger age groups. Thus, in case of women 5 carriers younger than 14 years old were registered and in case of men only 2 persons, the same as in the age group of 15-19 years old - 17 women carriers and only 4 men.

Although the incidence of new carriers is higher among men, in case of women the increase is faster - in case of men the number of carriers has doubled in 2007 compared to 2003 (from 6,5 to 13,9 new cases per 100 thousand inhabitants), while in case of women it became three times higher (from 3,3 in 2003 to 9,6 in 2006).

Health status of pregnant women

In 2007 there were registered 37090 pregnant women, 1275 cases more than in 2006. At the same time, the rate of deliveries in time from the total of pregnant women in 2007 represented 92,1%, 0,4% less than in 2006

Anaemia represents the main challenge in the health of pregnant women. 43,7% of the total of pregnant women suffered of this disease, this disease being responsible for complications in 245,8 deliveries per 1000.

Disabled persons

In 2007 there were recognized as disabled for the first time 13779 persons, of them - 5957 women (43%) and 7895 (57%) men, most of them residing in the rural area. The highest share of disabled persons is part of the age groups over 50 years old (more than half of them), which is also valid for all groups according to gender and place of residence.

Self-estimation of the health status

In disagreement with the statistical data on health, men appreciate their health status a little bit better than women. 50,9% of men appreciate their health status as being good and very good and only 43,1% of women do so.

Smoking and alcohol consumption

Smoking is a vice shared especially by men in the Republic of Moldova. The share of smokers among men is net higher than among women, irrespective of age.

The same thing is attested also with regard to indicators for alcohol consumption. Each second man consumes alcohol 1–2 times per week or more often, while, among women, this share is of 25%.

Obesity

Incidence of obesity in women is a little bit higher than in men, also valid for all age groups, with the exception of persons over 75 years old. The highest rate of obese people in both men and women is registered in the age groups 45–54 years old (29% women and 20% men) and 55– 4 years old (29% women and 22% men).

V. International migration

Both in 2006 and 2007 more people have emigrated from the Republic of Moldova compared to the number of people that immigrated. Gender differences are significant in sense that more women than men chose to emigrate, while in the Republic of Moldova came more male immigrants than female immigrants.

The most immigrants that came to the Republic of Moldova for study and work are from Turkey; however, if to take into account repatriated people, then the most of them are Moldovans. Depending on the nationality, Russian immigrants follow immediately the Moldovans, closely followed by Ukrainians.

The majority of refugees accepted in 2007 are men (over 70%).

VI. Labour market

Labour force and employment

In 2006 women represented almost half of the total of economically active population (approximately 49,14%), percentage which maintained at the same level also in 2007 (49,53%). Regarding residence area there are no significant differences for the last two years, although a slight decrease is noticed.

At the level of both years analyzed, the unemployment rate in women is lower than the unemployment rate in men (in 2006 it was by 3,6% lower in urban area and by 2,7% in rural area, and in 2007 it was by 3% lower than in urban area and by 1,9% in rural area). In 2007 it is noticed a general tendency of decrease of the unemployment rate, irrespective of sex and area of residence.

The share of inactive population at the level of the Republic of Moldova remains high, registering only slight fluctuations for the entire period of 2003-2007. Also the situation for the last two years remains the same: women inactivity rate in urban area in 2007 increased by 1,5 percentage points as compared to 2006, and in rural area - by 0,4%. In case of men, the inactivity rate increased in 2007 as compared to 2006 both in urban and rural areas.

The activity rate, as well as the employment rate decreases in case of women who have at least

one child of preschool age compared to men in the same situation – more women than men interrupt their activity or leave the labour market to take care of their children of preschool age.

The employment rate of adult women decreased the most – by almost 10% from 2003 till 2007. The employment rate in young women (15-24 years old) remained at the same level – the lowest one, registering in 2007 a more obvious decrease among young women.

Depending on the economic activities, distribution by gender of the employed population is maintained at the same level according to traditional segregation of the labour force: the most of the women work in the field of public administration, education, health and social assistance (176 thousand), followed closely by fields like commerce, hotels and restaurants (117 thousand), while men work especially in construction (78%), industry (39%), services and agriculture.

During the last 2 years the great majority of employed population from the Republic of Moldova were employees (approximately 70% women and more than 63% men). More men than women worked independently (33,9% men and 26,3% women). In terms of employers' share, this is very low and almost equal at the level of the entire female population and respectively employed male population – approximately 1%.

However, when it comes about employed population with a status of unpaid family aid, women represent the biggest majority, especially women from rural area (16.300 women from rural area more than men in 2006 and 12.700 more in 2007).

Gender distribution of employed population by type of production unit remained relatively the same during the last 2 years, thus:

- in formal sector the percentage of women and men is approximately equal (about 50%)
- in informal sector more men than women work (approximately 35% women and 65% men)
- in households the above mentioned percentage almost reverses, more than a half being women (approximately 55% women and 45% men).

Unemployment

Unemployment rate is lower among women than among men, during the two analysed years, both in urban and rural areas. In 2007 the unemployment rate of women in rural area almost halved. The causes of this phenomena should be analyzed deeply through special quantitative and qualitative studies, since this could be also due to the fact that the inactivity rate of women from rural

area is increasing, the same as the percentage of aged women. This would mean that the decrease of the unemployment rate in women from rural area is not due to policies for a more active employment, but due to the fact that more women attained the retirement age and others became housewives.

Inadequate working conditions and work accidents

Although the number of people working in dangerous or noxious conditions registered a slight decrease in 2007 compared to 2006, during both years more men than women were in this situation (by 29 thousand more men than women in 2006 and by 21,6 thousand more in 2007).

Work accidents happen more often in the case of men (401 cases in 2007) than in the case of women (149 cases in 2007), especially in terms of fatal accidents. In 2007 a slight decrease of work accidents was registered, yet the number of fatal accidents in case of men increased by 26% (10 men more than in 2006 died in work accidents).

Work remuneration

The data regarding work remuneration show that in 2006 women earned on average 32% less than men (only 68% of the average salary of men). In 2007 the difference decreased under 30%, reaching 27,36% (women earned 72,64% from the average salary of men).

In all the economic fields, during both years analyzed, women earned less than men, the only exception being fishing, where women earned in 2006, on average, 7% more than men and in 2007 the difference increased up to 21%. However, the number of people working in the fishing sector is very low, and that of women is even lower, being of only 100 women. The salary gap against women is maintained including those economic fields where women represent the majority of employees, like education, health and social assistance.

The highest average wage gap between women and men was in 2006 in the field of public administration, where women earned about 40% less than men. In 2007 this enormous gap reduced to 21%, below the annual average. It is interesting to notice that in this field the average salary decreased in 2007 as compared to 2006, women salary decreased on average only by 16 MDL, while that of men by 743 MDL. Moreover, this is the only field of economy where salaries decreased in 2007 as compared to 2006.

VII. Education

For the academic year 2006-2007 the share of male pupils in primary and general secondary education was about 100 persons higher than

the number of female pupils, and in the next year (2007/2008) their shares become equal. The share of boys in secondary vocational education is almost twice higher.

More girls than boys attend higher education institutions (by 20.4 thousand more in the academic year 2006-2007 and by 21,9 thousand more in 2007-2008).

Education as labour market is a strongly feminized field. From the total number of 49,4 thousand persons employed as teaching staff (in the academic year 2007/2008), women represent more than three-fourths. However, there are differences between education cycles, the highest share of women as teaching staff being in the primary and general secondary cycle (80.8%) and in colleges (70%), while in secondary vocational and higher education gender distribution is balanced.

Pre-school education

Although the number of children involved in pre-school education in the rural area is higher than in the urban area (31 thousand girls and only 33,3 thousand boys in 2007, compared to 26,6 thousand and respectively 29,2 thousand urban area), related to the total number of children by area indicate a very low coverage rate in rural area compared to towns.

The preschool education infrastructure, expressed as number of institutions, is increasing. In 2007 in the country were operating 1334 institutions, 29 units more than in 2006. The increase of the number of institutions, however, is not in harmony with the increase of the number of children. If making a calculation regarding the number of children per institution, this number is continuously increasing. In 2006 we had 89 children per institution, while in 2007 this number reached 90 children.

Primary and general secondary education

Girls rather than boys are enrolled in primary education before reaching the age of 7. In 2007, 3,2 thousand from 6,3 thousand pupils under 7 years old were girls, so more than half on one hand, on the other hand we remember that the share of girls in the younger age groups is lower than boys share, thus the percentage discrepancy is even higher.

The number of graduates of the pre-university education institutions is decreasing. The total number of graduates in 2007 was of 77,7 thousand persons, 3 thousand less than in 2006.

A decreasing tendency continues to be registered also in terms of the number of teaching staff, which doesn't register equal parameters from one year to another. The tendency of "feminization" of education as a labour market is a constant one, women representing about 80% of the teaching

staff, a ratio that did not suffer major changes from one year to another during 2003-2008.

Secondary vocational and secondary specialized education

Secondary vocational education is an education cycle toward which mainly boys are oriented, which in 2007/08 represent 65% of the graduates and pupils enrolled and over 66% of the total number of pupils.

"Masculinization" of the secondary vocational education is also among the teaching staff. Although teaching staff is equally distributed by genders (1,2 thousand women and 1,2 thousand men in 2007), men share is one much higher than generally in education (37,3 thousand women and only 12,1 thousand men in the academic year 2007/08).

Girls prevail numerically among pupils in colleges. In the academic year 2007/08 in the colleges of the country were studying 17,6 thousand girls and 13,7 thousand boys.

Gender distribution of pupils from secondary specialized education varies significantly from one branch group to another, fact that indicates that "masculinization" and "feminization" of some fields of economy is already taking place from the education institutions. Such branches like health protection (83,0% girls) or education (81,4%) are the fields where women represent the majority of employed population. And vice versa, fields like construction, transportation and agriculture are strongly "masculinized" in the labour market and in the education institutions.

Higher education

Girls prevail in higher education (6 out of 10 students being females) and girls share in 2007/08 academic year increased to 58,9% compared to 58% in the previous year.

The "feminized" fields are education (72,3% girls from the total number of students), healthcare (69,2%), economy (62,5%), arts and cinematography (61,5%). Fields with a numeric predominance of male students are physical culture and sports (80,0% boys), industry (64,8%), law (56,8%) and agriculture (55,1%). This segregation is valid also for the labour market, thus a cyclical evolution being produced.

In the academic 2007/08 about 42% of the staff of the higher education institutions had Doctor of Science or Ph.D. degree (2,7 thousand out of the total of 6,4 thousand). At the same time, this percentage was only of 31% among women, while among men - 55%.

Doctor and post-doctor degree

Although the percentage of male teaching staff with scientific degree of doctor is much higher com-

pared to women, at the same time, women enrolment in doctor studies is higher. In 2007 women were prevailing among graduates of doctor study (61%), both among those enrolled (64%) and the candidates for doctor's thesis (63%).

Post-doctor studies are strongly masculinized. In 2007, from 52 candidates for post-doctor's thesis only 17 were women. The same thing is valid also in case of the candidates for post-doctor's thesis enrolled in the same year – only 8 out of 23 and only in the case of graduates the distribution is a more fair one (6 women and 7 men).

Among Ph.D. from the activity of research and development (without pluralists) the share of women is even lower than in candidates for post-doctor's thesis: from 271 Ph.D. in 2007 only 41 were women.

VIII. Social protection

Pensions

During the whole period of 2004-2007, more women than men entered the category of pensioners. The share of pensioned women compared to men underwent a slight increase (from 20,4% in 2004 to 21,2% in 2007).

Men more often than women retire because of illness, their share reaching 25,8% from the total amount of retired men.

Men have a higher average pension for age limit than women. On average, women earn 12% less than men. This means that the pension system manages to reduce by 20% the difference of remuneration between women and men, existent on the labour market, by redistribution, thus in 2006 representing 32%.

The quantum of the average pension for age limit is very low and in 2007 it reached no more than 26% of the average salary per economy. Just because women, during their activity on the labour market, on average earn much less than men, the coverage rate of the average salary from pension is higher for women (29,7%) than in case of men (24,3%).

Social security

Women are better tax payers than men, their share being higher than that of men for both years: in 2006 approximately 7% more women than men contributed to the system of social security, and in 2007 by 5% - more.

With an overwhelming majority, women are the ones who take the traditional gender role of children rearing. Both in 2006 and 2007 more than 97% from the persons, who took child care leaves were women and only a little bit more than 2% were

men. In the urban area this ratio is over 99% for women and below 1% for men.

Only 1,5% of the fertile age women from the Republic of Moldova were in maternity leave in 2007.

Although it is praiseworthy that there is a special monthly indemnity for supporting single mothers with children between 1,5-16 years old, its quantum is not significant as a value, and it has remained at the same level (50 MDL) as in 2004, in spite of the inflation phenomenon.

The social security budget increased constantly from 2003 till 2007, almost twice. The biggest share goes to the pension budget (over 73% in 2007). Just a little bit over 3% is distributed for child care indemnities and 0,7% goes to birth indemnities.

During the period 2003-2007, the same number of shelter for elders and people with disabilities was maintained at national level (only 6), while the number of placed people was increasing each year. Thus, during the last years, each such a shelter has on average more than 360 people. The same thing is valid for the shelters for disabled children, which are only two. According to the data for 2007, such a shelter should accommodate more than 335 persons.

IX. Criminality

Delinquents

The phenomenon of law infringement in the Republic of Moldova is dominated by men, women representing a very small share among delinquents (13% in 2007). The share of girls among the minors committing crimes is even smaller (7,4% in 2007).

During 2003–2007 the general level of criminality remained relatively constant, with a slight decrease in 2007 both for men and women. At the same time, this phenomenon underwent a continuous and pronounced decrease among minors, beginning from 2004.

As types of crimes, the biggest share is due to robbery. At the same time, there are crimes specific to gender groups. Men commit more often such crimes as: deliberate infliction, robbery, hooliganism, while among women delinquents there are remarked as a higher number the crimes related to drugs.

The share of crimes committed by women is lower than those committed by men, regardless of residence area, and within gender groups there are no major differences according to the incidence of the crimes by area of residence.

Convicted persons

Amongst convicted persons, women also represent a noticeable minority at the general level

(12,7% in 2007). The share of girls is even smaller among the convicted minors (4% in the same year).

Since women commit less serious crimes, they are imposed less severe punishments compared to men. In 2007 just 13,3% of convicted women were imposed detention punishment, while 24,6% of men were imposed such a punishment.

During 2003-2007 the number of prisoners has continuously increased. Meanwhile, the number of convicted persons was decreasing during 2003-2005, and the number of persons in detention on remand decreased during 2005-2007. Women represented a very low share of the imprisoned persons (4,6% in 2007).

Due to the fact that women, in general, commit crimes at an elder age than men, the age structure for imprisoned women, has also shifted towards the elder age in comparison to imprisoned men.

Trafficked persons

The trafficking in human beings is a risk mostly aiming at women, these representing 91% of the total number of victims in 2007. At the same time, among trafficked minors, the gender distribution is more balanced, thus at this age the risk is also shared to a great extent by boys.

Victim's gender determines to a great extent the aim the person is trafficked for, women being often trafficked in order to be forced into prostitution, a phenomenon that is not characteristic to trafficked men, who are mostly in all the cases exposed to labour exploitation. This also determines the fact that women between 18-25 years old are more subject to the risk of being trafficked, while in case of men - elder people (over 25 years old);

The incidence of trafficking in men does not depend on the area of victim's residence, while for men there is a strong correlation in this sense, 85% of male victims in 2007 were from rural areas;

Road accidents

Men suffer more often than women from road accidents, in 2007 (which was the year with the biggest incidence of accidents in the time frame 2004-2007) suffered 2239 men and 1210 women;

Moreover, the death rate, caused by road accidents, from the total number of persons who suffered from road accidents is constantly higher amongst men than amongst women, thus resulting that men are involved in more serious accidents than women;

X. Living standards

In 2006 the majority of households of the Republic of Moldova having women as heads of households were formed of a single person, both in

urban area (35,3%) and rural area (46,3%). In the rural area this was also maintained in 2007, while in urban area takes place a slight inversion in the favour of households formed of 2 persons (33,1 % compared to 32,2%).

Rather women than men are heads of families formed of a single parent with children – in urban area 9,8% of the households are led by women and 0,8% are led by men and in rural area 7,6% of those led by women compared to 0,8% led by men.

In case of households led by women, the share of households having pension as a main source of income (22,8% in urban area and 30,8% in rural area) is only approximately by 20% lower than the share of those having as a main source of income other lucrative activities.

Also, in case of households having social payments as a main source of income, their share is higher at the level of households headed by women (7,8%) than in case of those lead by men (2,3%).

The majority of persons having as a main source of income money remitted from abroad are women between 19-29 years old (10%).

With regard to long term tangible goods, generally less of the households led by women possess such goods compared to households led by men. The biggest differences in rural area are in terms of computers, microwaves, automatic washing machines, and transportation means (bicycles and cars).

The total poverty rate registered a slight decrease in 2007 as compared to 2006. Nevertheless, in 2006 the poverty rate among households led by women was higher than among households led by men (31,8% compared to 29,4%). In 2007 the poverty rates for households led by women and those led by men were approximately equal (25,7% and 25,9%).

XI. International statistics

Population

Generally, the Republic of Moldova joins the same parameters with all the given states for comparison with regard to the age groups 0-14 years old and 15-64 years old. However it has the lowest rate of population over 65 years old – 6,4% women and 3,9% men, compared to 11,4% women and 8,1% men in Italy and 10,8% women and 5,5% men in Ukraine.

In 2005 only Romania had a higher infant mortality rate than the Republic of Moldova, the Russian Federation exceeding it only in terms of infant mortality rate in boys. At the same time, it had the highest mortality rate in children of 1-4 years old

among all states being compared, being followed closely by Romania.

At the level of this year, life expectancy at birth for women from the Republic of Moldova, is the lowest from the analyzed countries (11,5 years less than in case of women from Italy) and the last but one in case of men (13,8 years less than in case of men from Italy). Only the Russian Federation had a lower life expectancy for men (58,9 years compared to 63,8 years).

Women's political participation

The share of 22% of women members of the national Parliament, places the Republic of Moldova on the fourth position in the top of the best percentages at the level of states subject to comparison (after Germany with 32%, Belarus with 29% and Lithuania with 25% and at the same level with Bulgaria).

Labour market

In 2005, the Republic of Moldova was on the fifth place among the countries in comparison regarding the rate of women participation in labour force, less ahead of Romania and about 10% ahead of Italy. In 2006 women participation rate in labour force decreased by about 5%, while in the majority of the other countries it increased.

In 2006 the Republic of Moldova had the lowest unemployment rate among women (6%), in 2007 being outrun only by Lithuania, which succeeded in only one year to decrease the unemployment rate in women almost by half.

1. PARTICIPATION OF WOMEN IN THE PUBLIC AND POLITICAL LIFE

1.1. Participation in the central power structures, as of 14 April 2008

	Persons		in % to the total	
	W	M	W	M
Country's President	-	1	-	100
Presidential advisers	2	7	22.2	77,8
Cabinet of the President	7	10	41.2	58,8
Speaker of the Parliament	-	1	-	100
Cabinet of the Parliament	19	14	57.6	42,4
Members of the Parliament	22	79	21.8	78,2
Prime Minister	1	-	100	-
Vice Prime Ministers	-	2	-	100
Apparatus of the Government	3	7	30.0	70,0
Ministers	5	12	29.4	70,6
Vice Ministers	4	23	14.8	85,2
Directors of other central public administration bodies	2	9	27.3	72,7
Vice Directors	2	7	36.4	63,6
Chairman of the Constitutional Court	-	1	-	100
Chairman of the Supreme Court of Justice	-	1	-	100

It is considered that the dimensions giving power to a group to have a say in the decisions taken at the level of the whole should represent not less than 30%. Considering that in the above table only 4 are the positions where women reach and exceed this level, and these are rather executive positions and not decision-taking, lead us to the conclusion that women are sub-represented at the decisional level of the central power in the Republic of Moldova. This is valid both when talking about the so-called decisional positions of front rank and decisional positions of second rank. The only positions where women exceed 40% or represent more than a half are rather organizational positions, executive within the Cabinet of the President (41,2% women) and within the Cabinet of the Parliament (57,6% women). Also, 36,4% women are vice directors of other central public administration bodies.

Nevertheless, it should be noticed that, for the first time, the cabinet of the Republic of Moldova is led by a woman and women's share in the composition of the current Government is of 30%. It should be also noticed that the Ministry of Finance, a field considered eminently a male field, is led by a woman.

1.2. The number of the members of the Parliament by faction and parliamentary political parties, as of 14 April 2008

	Persons		in % to the total	
	W	M	W	M
Total	22	79	21.8	78.2
The parliamentary faction of the Communist Party in the Republic of Moldova	13	42	23.6	76.4
The parliamentary faction of "Moldova Noastra" Alliance	0	13	0.0	100.0
The parliamentary faction of the Christian Democratic Popular Party	3	4	42.9	57.1
The parliamentary faction of the Democratic Party of Moldova	3	8	27.3	72.7
Independent members of the Parliament	3	12	20.0	80.0

At the level of the Parliament, the share of women is 21.8%, the most of the women members of the Parliament coming from the Communist Party of the Republic of Moldova (13). However, only 23,6% of the members of the Parliament from this party are women, while the Democratic Party of Moldova has a share

of 27,3% of women, and the “Moldova Noastra” Alliance does not have any women as a member of the Parliament. Although the Christian Democratic Popular Party has the smallest number in the Parliament, succeeded to establish the best balance between genders at the level of its members of the Parliament, with a share of 42,9% women.

1.3. The structure of the leading staff of the ministers and central public administration bodies, as of 14 April 2008

Ministries/ central public administration bodies	Minister/ Director		Vice Minister/ Vice Director		Director/ head (of department/ division / service)		Deputy head of department/ division/ service	
	W	M	W	M	W	M	W	M
Ministry of Foreign Affairs and European Integration	-	1	1	1	22	45	4	9
Ministry of Economy and Commerce	-	1	-	2	11	13	10	5
Ministry of Finance	1	-	1	1	22	11	12	6
Ministry of Agriculture and Food Industry	-	1	-	2	4	15	-	3
Ministry of Transport and Road Management	-	1	-	1	2	2	-	2
Ministry of Constructions and Territorial Development	-	1	-	1	2	2	1	1
Ministry of Ecology and Natural Resources	1	-	-	-	3	2	3	-
Ministry of Education and Youth	1	-	-	2	8	4	2	1
Ministry of Health	1	-	-	3	6	9	7	2
Ministry of Social Protection, Family and Child	1	-	1	1	14	19	2	-
Ministry of Culture and Tourism	-	1	-	-	2	3	6	-
Ministry of Justice	-	1	1	1	10	2	6	-
Ministry of Internal Affairs	-	1	-	4	2	15	-	-
Ministry of Defence	-	1	-	1	-	6	-	4
Ministry of Informational Development	-	1	-	1	4	13	-	4
Ministry of Reintegration	-	1	-	1	-	2	-	-
Ministry of Local Public Administration	-	1	-	1	3	3	2	2
Interethnic Relations Bureau	1	-	1	-	3	-	-	-
National Statistics Bureau	-	1	-	1	12	3	13	1
Border Service	-	1
Customs Service	-	1	-	1	10	20	4	6
Forestry Agency “Moldsilva”	-	1	-	-	1	2	-	-
Agro-industrial Agency “Moldova - Vin”	-	1	-	-	1	1	-	1
Material Reserves, Public Acquisitions and Humanitarian Aid Agency	-	1	-	1	6	5	6	1
Cadastral and Land Relations Agency	-	1	-	1	4	6	-	-
Centre for Combating Economic Crime and Corruption	-	1	-	2	13	56	1	10
Licensing Chamber	1	-	1	-	2	3	2	3
Sports Agency	-	1	-	1	1	4	1	-

If to take a general look, we find out that gender distribution at the level of leadership of the ministries, national agencies and other central bodies is relatively balanced (approximately 41% women and 59% men). However, while advancing on the hierarchical scale of decision taking positions, the gender gap increases: at the level of directors/heads (of department, service) there are 38,5% women and 61,5% men, at the level of Vice Minister/Vice Director a share of less than 20% women is reached (18,4% compared to 81,6% men) and at the level of Minister/Director there are 26,7% women and 73,3% men.

1.4. Number of women working in law-enforcement bodies

Name of the subdivisions and subordinated institutions	Persons		%	
	W	M	W	M
Ministry of Justice	67	19	77.9	22.1
Subordinated institutions				
Department of Penitentiary Institutions	46	50	47.9	52.1
Executive Department	30	18	62.5	37.5
Legal Information Centre	7	4	63.6	36.4
National Centre for forensic examination	34	28	54.8	45.2
Centre for Legislation Harmonisation	9	1	90.0	10.0
Legal Administration Department	2	4	33.3	66.7
Justice Department of the Territorial Autonomous Unit of Gagauzia with special status (Gagauz-Yeri)	5	2	71.4	28.6
Total:	200	126	61.3	38.7

The situation described above repeats also in the case of law-enforcement bodies, in sense that, at general level, women represent 77,9% of the employees of the Ministry of Justice, but we don't have a distribution of the existent positions within the Ministry of Health from the perspective of the decisional power compared to executive positions.

Again, women form the majority of persons working in the institutions subordinated to the Ministry of Justice (61,3%), and again we don't know the gender distribution depending on the decision-taking positions compared to the executive ones.

1.5. Participation in local power structures

	As of 14.10.2005			As of 14.04.2008		
	Total	women		Total	women	
		persons	in % to the total		persons	in % to the total
Rayon presidents	32	1	3.1	32	1	3.1
Bashkan (Governor) of the TAU Gagauzia	1	-	0	1	-	0
Mayors of municipalities and towns and villages (communes)	898	133	14.8	898	157	17.5

At the level of the local power in terms of women sub-representation, things seem to be worse: only 1 woman from 32 persons is a rayon president and only 17,5% women were elected as mayors of municipalities, towns and villages (communes).

At local level, the only position where women are more numerous as compared to men is that from the last hierarchical place, i.e. consultant/specialist (68,4% women). In terms of head of departments/units, gender distribution is relatively balanced (47,3% women), afterwards, absolutely all the important decision-taking positions at local level (town councillors – 71,3%, rayon councillors – 83,4%, municipal councillors – 66,7%, mayors/deputy mayors – 83,1%, president/vice-presidents – 92,6%) are held mostly by men (see table 1.6)

1.6. Elected persons and staff of the local public administration, as of 14.04.2008

	Chairperson / vice-chairperson		Mayor / Deputy mayor		Municipal councillors		Rayon councillors		Town/ village councillors		Head of departments/ units /sections		Consultant /specialist	
	M	W	M	W	M	W	M	W	M	W	M	W	M	W
Mun. Chişinău														
Municipal mayor-alty	1	-	4	-	34	17	-	-	-	-	10	13	22	61
Municipal council	-	-	-	-	-	-	-	-	-	-	78	93		294
Praetor's offices in Chişinău	-	-	12	2	-	-	-	-	-	-	10	20	52	60
Mayor' offices in Chişinău	-	-	27	3	-	-	-	-	231	61	-	-	51	92
North														
Mun. Bălţi			3	1					48	9	7	14	26	71
Briceni	3		25	7			28	5	230	92	5	4	39	36
Donduşeni	2		18	5			21	6	169	67	4	5	20	35
Drochia	2		24	4			31	2	230	94	4	6	64	147
Edineţ	1		24	8			29	4	247	111	6	4	44	167
Făleşti	2	2	26	8			31	2	296	124	3	6	25	40
Floreşti	2		30	10			26	7	278	166	4	3	15	49
Glodeni	3	1	16	3			30	3	154	71	6	4	19	64
Ocniţa	3		18	3			23	10	153	90	5	4	16	26
Rîşcani	2	1	26	4			28	5	219	97	13	57	46	100
Sîngerei	3		22	4			29	3	237	89	41	29	32	19
Soroca	2		30	5			29	6	282	108	24	12	51	130
Centre														
Anenii Noi	3		19	7			15	8	234	90	7	4	43	156
Călăraşi	4		26	3			26	7	241	85	9	11	69	149
Criuleni	4		20	7			27	6	218	85	8	10	45	115
Dubăsari	2		11				20	7	101	40	4	4	10	13
Hînceşti	3	1	33	6			29	6	349	132	6	3		157
Ialoveni	2	1	27	3			28	5	246	81	8	5	99	202
Nisporeni	2		20	3			29	4	211	60	3	5	13	35
Orhei	4		29	9			29	6	328	116	8	3	20	41
Rezina	3		21	4			17	6	188	114	8	3	20	49
Străşeni	2		23	4			27	6	244	79	9	8	9	31
Şoldăneşti	2		20	3			24	3	150	92	6	4	17	49
Teleneşti	2		24	7			26	7	261	88	7	4	7	1
Ungheni	3	1	52	9			30	5	252	106	9	37	54	131
South														
Basarabasca	2		9				23	3	68	24	7	5	6	35
Cahul	2		27	10			31	4	312	125	11	7	36	53
Cantemir	3		22	6			29	4	214	92	7	0	49	138
Căuşeni	3		21	6			30	3	238	106	9	1	88	164
Cimişlia	3		21	2			28	5	191	76	7	5	21	20
Leova	3		19	6			20	12	174	95	6	5	29	53
Ştefan-Vodă	3		26	3			20	6	227	91	7	12	33	139
Taraclia	3		14				30	3	145	57	7	5	16	25
T.A.U. Găgăuzia	3		25	1			24	3	300	79	2	3	44	97

2. POPULATION

2.1. Number of women and men at the beginning of the year

thousand persons

	Total	W	M	Women per 100 men
2007 total	3581,1	1860,1	1721,0	108,1
urban	1478,0	783,2	694,8	112,7
rural	2103,1	1076,9	1026,2	104,9
2008 total	3572,7	1855,2	1717,5	108,0
urban	1476,1	782,3	693,8	112,8
rural	2096,6	1072,9	1023,7	104,8

In 2007, the population of the Republic of Moldova was consisting of 52% women and 48% men. The share remains the same in 2008, too. The share of women in urban area increased up to 53%.

It is noticed a slight decrease of the number of population in 2008 compared to 2007 (8,4 thousand persons), the most significant difference being at the level of rural area (6,5 thousand persons less than in 2008 compared to 2007). The number of women from rural area is 4 thousand persons less in 2008 than in 2007, while the number of men in rural area is 2,5 thousand persons less than in 2007. In urban area there is also noticed a slight decrease of the number of population: in 2008 there are 9 hundred women less than in 2007 and 1 thousand men less than in 2007.

Age pyramid as of 1 January 2008

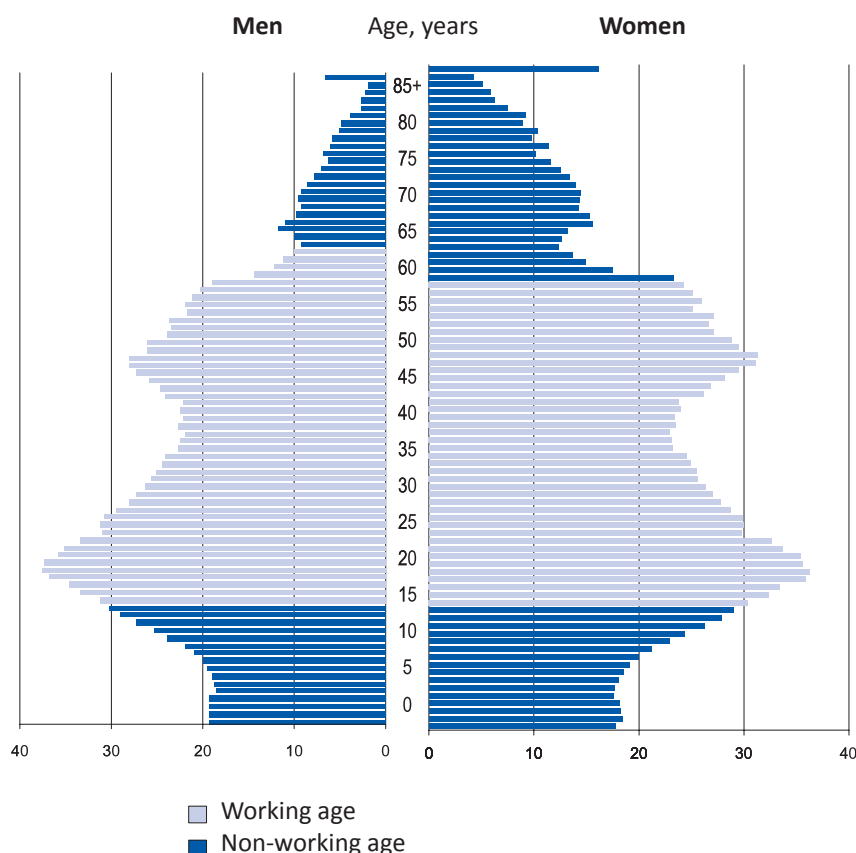

It is noticed that the most of population of the Republic of Moldova, both women and men are of working age.

2.2. Number of population by some age groups

thousand persons

Age group, years	01.01.2007				01.01.2008			
	Urban		Rural		Urban		Rural	
	W	M	W	M	W	M	W	M
Total	783,2	694,8	1076,9	1026,2	782,3	693,8	1072,9	1023,7
0-14	110,0	116,7	207,6	216,1	105,9	112,7	200,2	209,0
16-64	595,5	532,4	717,4	716,8	597,8	534,2	721,5	722,3
65-79	63,9	40,2	122,3	79,5	64,1	40,8	121,1	78,3
80+	13,8	5,5	29,6	13,7	14,5	6,0	30,1	14,1

The biggest part of population of the Republic of Moldova makes part from the age group 15-64 years old: 76% of the women from urban area and 66,6% of the women from rural area compared to 76,6% of men from the urban area and 70% of men from rural area.

Working age population represents 71% of female population and 73% of male population. In this context, the dependency rate, expressed as the number of persons of non-working age (children, elders) per one working age person is higher among women (0,41) than in case of men (0,37).

However, the differences by gender are minimal as compared to those by area of residence. Thus, the share of working age population in urban area (77% of the total) is by 8 percentage points higher than in rural area, This is also reflected in the dependency rate, which represents 0,3 for the urban area and 0,45 for rural area.

2.3. Number of population in territorial aspect, as of 01.01.2008

thousand persons

	Total		Urban		Rural	
	W	M	W	M	W	M
Total	1855,2	1717,5	782,3	693,8	1072,9	1023,7
Mun.Chisinau	416,5	368,6	381,7	335,0	34,7	33,6
North	533,4	484,5	188,8	166,7	344,7	317,8
mun. Balti	80,2	67,9	77,6	65,6	2,6	2,3
Briceni	40,2	36,4	8,1	7,3	32,1	29,1
Donduseni	24,7	21,6	5,8	4,9	19,0	16,7
Drochia	48,0	43,5	10,7	9,6	37,3	33,9
Edinet	44,2	39,6	13,8	12,2	30,4	27,5
Falesti	48,3	45,3	9,2	8,4	39,1	36,9
Floresti	47,6	43,9	10,1	9,1	37,5	34,8
Glodeni	32,7	30,2	6,1	5,6	26,6	24,6
Ocnita	30,0	26,8	10,3	9,2	19,7	17,6
Riscani	37,1	34,2	8,3	7,6	28,8	26,6
Singerei	48,1	45,8	9,8	9,0	38,3	36,8
Soroca	52,3	49,2	19,0	18,3	33,4	30,9
Centre	545,4	521,1	107,1	96,7	438,2	424,3
Anenii Noi	42,6	40,5	4,6	4,0	37,9	36,6
Calarasi	40,6	39,0	8,4	7,6	32,2	31,4
Criuleni	37,2	35,6	4,3	4,0	32,9	31,6
Dubasari	17,9	17,3	0,0	0,0	17,9	17,3
Hincesti	62,6	60,9	8,9	7,9	53,7	53,0
Ialoveni	49,8	48,2	7,8	7,3	42,0	40,9
Nisporeni	34,2	33,2	7,6	7,1	26,6	26,1
Orhei	65,5	60,4	17,8	15,4	47,8	45,0
Rezina	27,0	26,2	6,9	6,6	20,2	19,5
Straseni	46,6	44,9	11,0	10,5	35,6	34,4
Soldanesti	22,6	21,5	4,0	3,6	18,7	17,9
Telenesti	37,8	37,2	4,3	3,9	33,4	33,3
Ungheni	61,1	56,1	21,7	18,9	39,4	37,3

	Total		Urban		Rural	
	W	M	W	M	W	M
South	277,1	266,5	70,8	64,9	206,3	201,6
Basarabeasca	15,2	14,3	6,5	6,0	8,7	8,3
Cahul	64,2	59,6	21,0	18,0	43,2	41,6
Cantemir	31,7	31,7	3,2	2,9	28,6	28,8
Causeni	47,3	45,6	12,6	11,9	34,7	33,7
Cimislia	32,0	30,9	7,4	6,8	24,7	24,0
Leova	27,0	26,9	7,9	7,8	19,1	19,1
Stefan Voda	36,7	35,8	4,5	4,2	32,2	31,6
Taraclia	22,9	21,7	7,8	7,2	15,1	14,5
TAU Gagauzia	82,9	76,8	33,9	30,4	49,0	46,4

In territorial aspect, population of the Republic of Moldova is distributed like this:

- Centre region has the most of the inhabitants: 29,4% of the total of women and 30,34% from the total of men at republican level;
- North region: 28,75% from the total of women and 28,21% from the total of men;
- Municipality of Chisinau: 22,45% from the total of women and 21,46% from the total of men;
- South region: 14,93% from the total of women and 15,52% from the total of men;
- TAU Gagauzia: 4,47% from the total of women and 4,47% from the total of men.

2.4. Population structure by some age groups in territorial aspect, as of 01.01.2008

percents

ATU	0-15		16-56/61		57/62+	
	W	M	W	M	W	M
Total	18,1	20,5	62,4	69,7	19,5	9,8
Mun. Chisinau	14,0	16,9	70,4	75,3	15,6	7,8
North	17,5	20,1	57,5	66,7	24,7	13,0
Mun. Balti	14,2	17,4	67,2	73,3	18,6	9,3
Briceni	17,0	19,8	54,0	64,2	29,0	16,0
Donduseni	15,9	19,4	51,8	62,9	32,3	17,7
Drochia	17,2	19,8	54,2	64,4	28,6	15,8
Edinet	16,7	19,3	55,1	65,2	28,2	15,5
Falesti	20,3	22,0	57,1	66,1	22,6	11,9
Floresti	18,2	20,7	57,3	66,8	24,5	12,5
Glodeni	18,9	21,3	56,7	66,0	24,4	12,7
Ocnita	14,9	17,8	58,2	68,0	26,9	14,2
Riscani	17,6	20,6	54,6	64,2	27,8	15,2
Singerei	22,3	23,9	57,4	66,2	20,3	9,9
Soroca	18,2	20,5	57,8	67,9	24,0	11,6
Centre	20,2	22,2	61,6	68,8	18,0	8,8
Anenii Noi	19,3	20,7	63,4	70,9	17,3	8,4
Calarasi	20,0	21,6	59,6	68,3	20,4	10,1
Criuleni	19,7	22,6	63,5	69,9	16,8	7,5
Dubasari	18,8	21,3	62,9	70,3	18,3	8,4
Hincesti	21,1	22,7	61,4	68,3	17,5	9,0
Ialoveni	20,4	22,0	64,5	71,1	15,1	6,9
Nisporeni	22	23,5	60,5	68,1	17,5	8,4
Orhei	18,6	21,4	62,6	69,9	18,8	8,7
Rezina	19,3	20,7	61,0	69,9	19,7	9,4
Straseni	20,0	21,7	62,8	69,9	17,2	8,4
Soldanesti	21,0	23,1	56,4	65,2	22,6	11,7
Telenesti	22,8	24,4	58,9	66,5	18,3	9,1
Ungheni	20,3	23,4	61,2	67,2	18,5	9,4

ATU	0-15		16-56/61		57/62+	
	W	M	W	M	W	M
South	20,5	22,2	60,7	68,5	18,4	9,0
Basarabeasca	19,9	21,5	62,9	70,2	17,2	8,3
Cahul	19,9	21,8	62,2	69,3	17,9	8,9
Cantemir	22,7	24,1	60,6	67,8	16,7	8,1
Causeni	20,0	22,6	60,9	68,2	19,1	9,2
Cimislia	20,9	22,3	60,5	68,5	18,6	9,2
Leova	21,1	22,1	61,2	69,5	17,7	8,4
Stefan Voda	21,5	22,7	59,2	67,9	19,3	9,4
Taraclia	18,6	19,9	59,8	69,8	21,6	10,3
TAU Gagauzia	18,9	21,5	63,1	69,6	18,0	8,9

The age pyramid in territorial aspect is relatively uniform and follows the same model:

- in the age group 0-15 years old, the number of female population is always lower than the male one;
- in the age group 16-56/61 years old, the number of female population is lower than the male one;
- in the age group over 57/62 years old, the percentage reverses, women share being always higher than that of men.

2.5. Population ageing coefficient

(number of people aged 60 and over per 100 inhabitants)

	2006		2007	
	W	M	W	M
Total	15,6	10,7	16,0	11,2
Urban	13,6	9,8	13,3	9,7
Rural	17,0	11,3	18,0	12,2

2.6. Population ageing coefficient by area of residence in 2003-2007

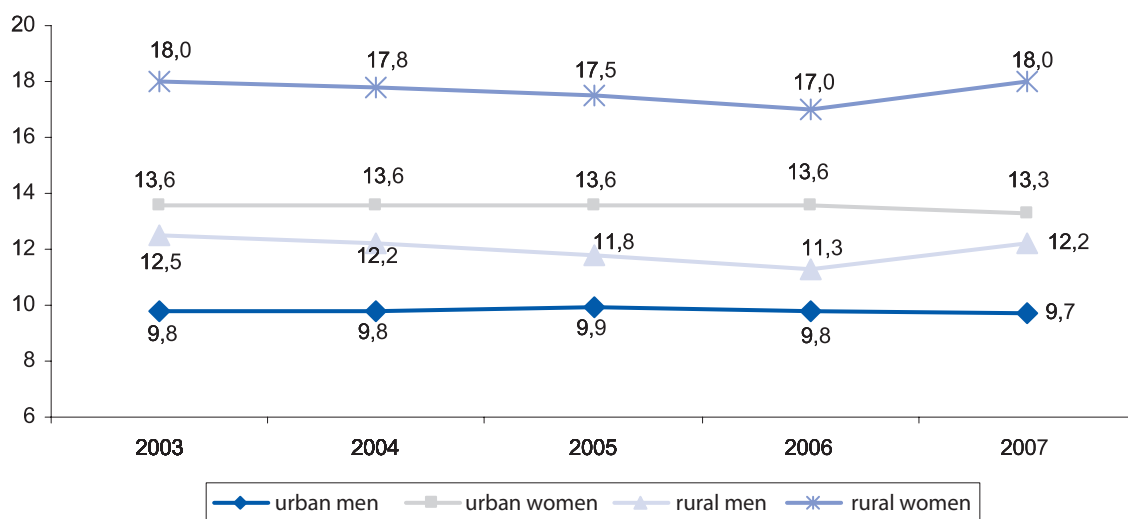

The evolution of the population ageing coefficient shows this coefficient is lower among men than among women. The differences between groups represent 7,8 points in rural area and 3,5 in urban area.

During 2003-2007 population ageing coefficient remained relatively constant in urban area, while in rural area it decreased until 2006 and then increased in 2007 again at the level for 2003. This decrease was, first of all, due to birth rate increase during that period, which was determined by the fact that generations born in 80's attained fertile age. In 80's birth rate reached the highest levels.

2.7. Life expectancy at birth and certain ages

Years left

Age, years	2006				2007			
	Urban		Rural		Urban		Rural	
	W	M	W	M	W	M	W	M
0	74,1	66,5	71,1	63,3	74,4	66,5	71,5	64,2
5	70,2	62,6	67,1	59,4	70,4	62,6	67,6	60,2
15	60,3	52,8	57,3	49,6	60,5	52,7	57,7	50,5
25	50,5	43,2	47,6	40,1	50,7	43,2	48,0	41,1
50	27,1	22,1	24,6	19,7	27,3	22,2	25,0	20,5
60	18,9	15,6	16,9	13,7	19,1	15,7	17,4	14,4

Women's life expectancy is higher than that of men, both at birth and any age. Life expectancy at birth for women from urban area was almost 8 years higher than that of men in 2007, and in rural area by 7,3 years higher. At the age of 60, life expectancy of women is 3,4 years higher than that of men in urban area, and in rural area 3 years higher. Compared to 2006 it is noticed an increase of life expectancy at all ages, yet insignificant (less than one year).

Population ageing coefficient for the period 2003-2007 remains relatively at the same parameters. Due to women's higher life expectancy and higher number of women than men at the population level, there are more aged women than men. The highest population ageing coefficient is among women from the rural area (by 18 women over 60 years old per 100 inhabitants compared to 12,2 men over 60 years old per 100 inhabitants).

Case study – example of statistical data use

Population ageing appears when the average age of population at the level of a country or region increases. With the exception of 18 countries, this process takes place at the level of each country and region of the world, being generalized. Population ageing means an increase of population of advanced age groups. Thus, an increase of the average age of population, a decrease of the proportion of population composed of children or an increase of the share of aged population represent aspects of the population ageing process.

Population ageing is the most obvious in the developed countries. In Japan, one of the countries with most quick population ageing rate, there were 9,3 people under 20 years per every person of over 65 years in 1950. Forecasts say that till 2025 this proportion will be of 0,59 people under 20 years old per each person over 65 years old. At global level the figures are increasing, however: in 1950 there were 23,9 people, in 2000 – 26,8 people, and the forecasts for 2050 indicate 37,8 persons under 20 years old per each person over 65.

The causes of population ageing lay in two demographic phenomena (possibly interrelated): increase of life expectancy and decrease of fertility rate. An increase in longevity increases population average age by increase of the number of years in which each person is aged compared to the number of years in which the person is young. A description of the fertility rate increases population average age by changing the balance from the recently new-born towards people born in the past. Out of these two phenomena, the decline of the fertility rate is dominant in the population ageing process to which we assist. More clearly, the decline of the total fertility rate in the last half of the century bears

responsibility for the process of population ageing taking place in the developed countries. However, because the developing countries pass a very quick transition towards the decrease of the fertility rate, they will experiment in the future such processes of population ageing even more rapidly than the developed countries.

Asia and Europe are 2 regions where a significant number of countries have to face severe population ageing in the near future. In 20 years by now, many states from these regions will be in a situation in which the highest deciles of population will be population over 65 years old and the average age of population will get alarmingly close to 50 years.

Population ageing increases several categories of budgetary expenses: health protection expenses will increase dramatically as population gets older. The Governments will get in the situation of choosing either to increase the taxes or to get less involved in providing health services. The social protection systems already experiment difficulties due to longevity increase. The increase of the pension period wasn't yet counterbalanced with an increase of the working period on the labour market, fact that leads to a decrease of the level of pensions, and this tends to continue.

Gender analysis of the population ageing process and of the decrease of social protection shows specific problems women face both as aged people and persons taking care of aged people. Women represent the majority of the most aged people from the group of aged people; they are the most exposed to the risk of lacking financial support; living without a spouse with the family members and of being taken care by the women from the family.

3. NATURAL MOVEMENT OF POPULATION

BIRTH RATE

3.1. Number of live births

persons

	2006				2007			
	Urban		Rural		Urban		Rural	
	W	M	W	M	W	M	W	M
Live births - total	6669	6910	11608	12400	6600	7079	11727	12567
of them:								
within marriage	5248	5456	8739	9403	5297	5694	8858	9492
outside marriage	1421	1454	2869	2997	1303	1385	2869	3075

3.2. Live births outside marriage by area of residence in 2003-2007, in %

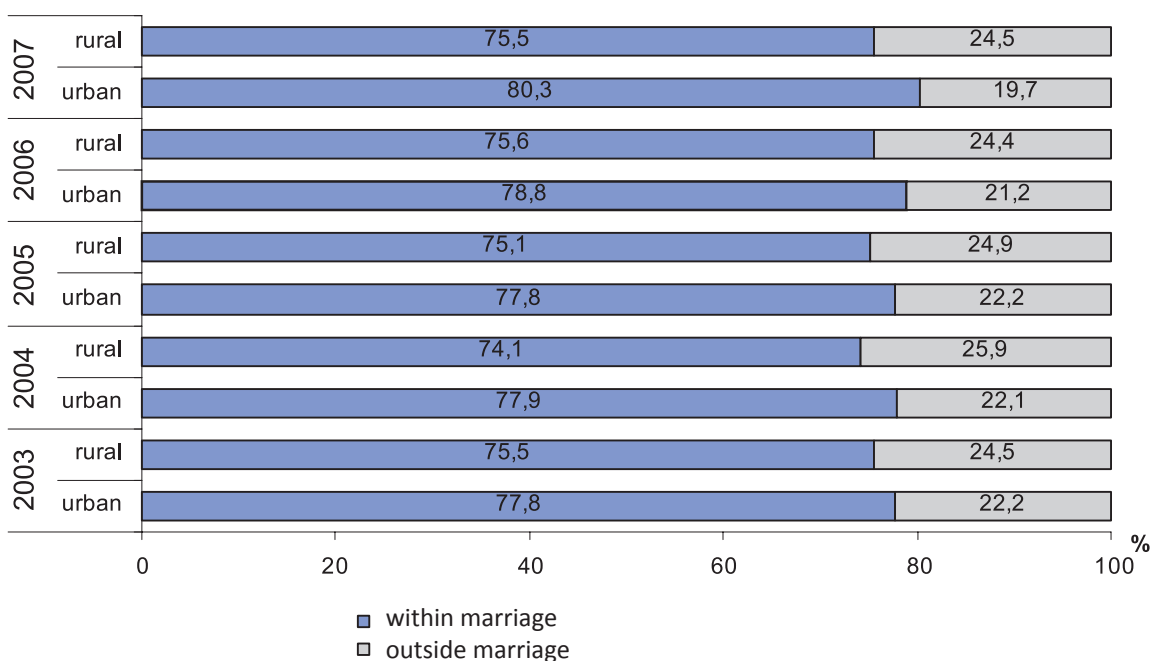

Always more boys than girls are born per year. In 2006 from the total of live births, 51,37% were boys and 51,74% - in 2007. Over 60% of births (live births of both sexes) take place in rural area.

During 2003 – 2007 over 74% of births were within marriage, births outside marriage being about 20%. However, there are differences in terms of residence area, with higher births rates outside marriage in rural area (between 24,4% and 25,9%). For the same period it is noticed a slight decrease of births outside marriage in urban area, but only under one percent.

3.3. Live births by mother's age group

persons

Age group, years	2006		2007	
	Urban	Rural	Urban	Rural
Total	13579	24008	13679	24294
under 16	17	54	11	64
16-19	1152	3659	927	3289
20-24	4696	10067	4675	10407
25-29	4376	6160	4496	6224

Age group, years	2006		2007	
	Urban	Rural	Urban	Rural
30-34	2356	2881	2505	3029
35-39	849	966	918	1069
40-44	132	218	137	204
45-49	1	3	10	5
50 and over	-	-	-	3
Average age at first delivery	23.8	21.8	24.0	22.1

3.4. Live births by mother's age group by area of residence in 2007, in %

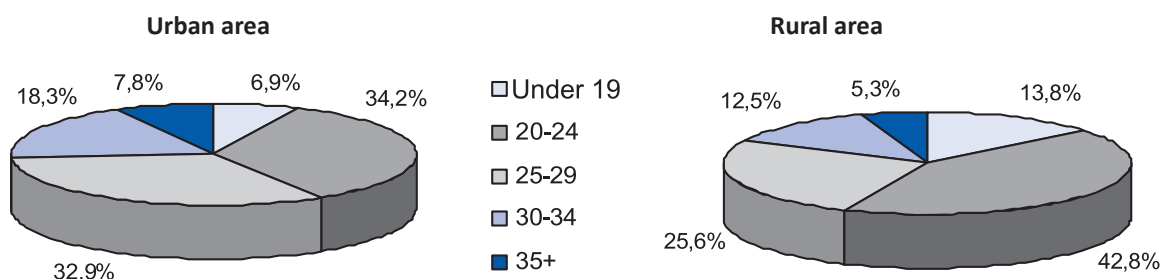

The highest number of births both in 2006 and in 2007 takes place in women from the age group 20-24 years old irrespective of the residence area (approximately 34% for urban area and 42% for rural area). Regarding delivery of mothers under 16 years of age, these represent 0,22% from the total of births from the rural area and 0,13% from the total of births from the urban area. In 2007 it is noticed a slight decrease of the number of births for this age group of mothers in urban area (8 births less) and a slight increase in the rural area (10 births more).

The notable differences between urban and rural area are those from the age group 16-19 years and 30-34 years old:

- For the age group 16-29 years old: in 2006 about 15,24% from the total number of births in the rural area happened in this age group, compared to only 8,5% from the total number of births in the urban area. There is a slight tendency of decrease in the number of births for 2007 in this age group.
- For the age group 30-34 years old: in 2007 there is a difference of almost 6 percents in the favour of births in urban area compared to births in rural area.

Also, there is a difference of 2 years in the average age of women at first delivery in the urban area compared to rural area.

3.5. Distribution of live births by newborn's rank

The numerical order of a child in the number of children born by a woman	2006		2007	
	Urban	Rural	Urban	Rural
Total	13579	24008	13679	24294
of them:				
first	7674	12185	7538	12561
second	4740	7690	4914	7683
third	860	2676	921	2732
forth and more	305	1457	306	1318

persons

3.6. Distribution of live births by newborn's rank by area of residence in 2007, in %

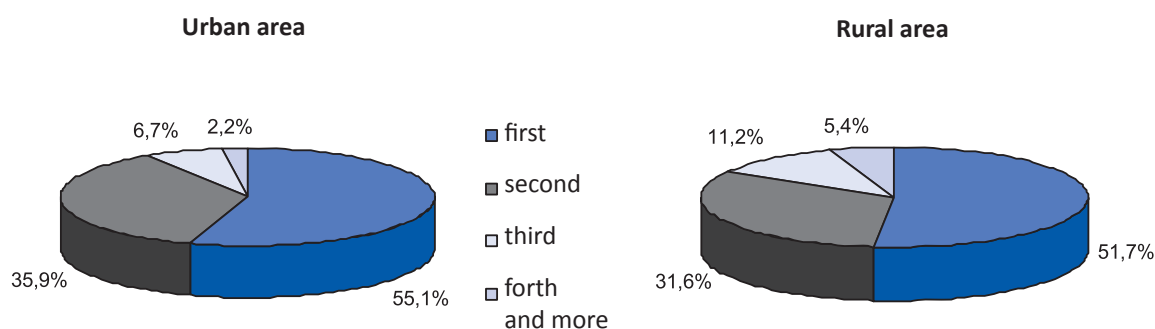

In 2007, for more than half of the women from the Republic of Moldova who gave birth it was their first child and for more than 30% it was their second child. The percentages are valid irrespective of the area of residence. There is a difference of 4,5% in favour of women from rural area when talking about giving birth to a third child and another one of 3,2% for four and more children.

3.7. Number of live births in territorial aspect, in 2007

ATU	Persons				Per 1000 inhabitants			
	Urban		Rural		Urban		Rural	
	W	M	W	M	W	M	W	M
Total	6600	7079	11727	12567	8,4	10,2	10,9	12,3
Mun. Chisinau	3023	3279	458	500	8,0	9,8	13,2	14,9
North	1616	1697	3210	3476	8,5	10,2	9,3	10,9
Mun. Balti	650	706	27	21	8,4	10,8	10,5	9,0
Briceni	70	72	275	335	8,6	9,8	8,6	11,5
Donduseni	46	44	155	142	8,0	8,9	8,1	8,5
Drochia	86	87	344	332	8,0	9,0	9,2	9,8
Edinet	117	116	249	277	8,5	9,5	8,1	10,1
Falesti	85	94	442	466	9,1	11,0	11,3	12,6
Floresti	97	110	357	399	9,6	12,1	9,5	11,4
Glodeni	54	61	236	251	8,7	10,8	8,9	10,2
Ocnita	83	75	163	167	8,1	8,1	8,2	9,5
Riscani	87	81	242	280	10,3	10,6	8,4	10,5
Singerei	82	98	434	482	8,4	10,9	11,2	13,1
Soroca	159	153	286	324	8,4	8,4	8,6	10,5
Centre	964	1021	5137	5529	9,0	10,5	11,7	13,0
Anenii Noi	40	44	396	434	8,6	11,1	10,4	11,9
Calarasi	74	70	338	395	8,7	9,1	10,5	12,6
Criuleni	27	43	417	475	6,1	10,6	12,7	15,1
Dubasari	-	-	172	200	-	-	9,6	11,5
Hincesti	67	101	618	666	7,5	12,6	11,5	12,5
Ialoveni	100	85	537	591	13,0	11,8	12,8	14,5
Nisporeni	54	59	338	340	7,0	8,1	12,7	13,0
Orhei	149	151	571	560	8,3	9,8	12,0	12,4
Rezina	67	57	210	240	9,8	8,6	10,4	12,3
Straseni	120	115	472	472	10,9	11,0	13,3	13,7
Soldanesti	42	39	191	223	10,6	10,8	10,2	12,4
Telenesti	35	38	373	420	8,0	9,6	11,1	12,6
Ungheni	189	219	504	513	8,7	11,6	12,8	13,8
South	616	656	2277	2389	8,6	10,0	11,0	11,8
Basarabasca	75	83	78	83	11,4	13,8	9,0	10,0
Cahul	167	190	456	515	7,9	10,5	10,6	12,4
Cantemir	21	20	336	369	6,7	7,0	11,7	12,8
Causeni	123	126	405	411	9,7	10,5	11,7	12,2
Cimislia	43	39	213	231	5,7	5,6	8,6	9,6
Leova	78	75	246	236	9,8	9,5	12,8	12,3
Stefan Voda	43	45	390	401	9,5	10,5	12,0	12,6
Taraclia	66	78	153	143	8,5	10,8	10,1	9,9
TAU Gagauzia	295	353	612	643	8,6	11,5	12,5	14,0

3.8. Number of live births outside marriage in territorial aspect

persons

ATU	2006				2007			
	Mother's age group, years				Mother's age group, years			
	under20	20-29	30-39	40 +	under20	20-29	30-39	40 +
Total ¹	1921	5171	1560	87	1802	4989	1732	109
Mun. Chisinau	165	759	415	28	135	633	428	27
North	572	1399	446	17	518	1378	499	31
Mun. Balti	44	128	74	1	32	138	77	4
Briceni	42	63	23	1	39	76	23	2
Donduseni	37	58	16	-	20	61	30	1
Drochia	55	139	40	1	62	114	47	3
Edinet	53	96	34	2	39	105	37	1
Falesti	62	180	54	2	64	175	61	4
Floresti	54	153	34	1	50	133	49	4
Glodeni	41	106	36	1	39	95	27	-
Ocnita	39	72	26	2	38	96	21	3
Riscani	33	87	21	2	29	100	25	4
Singerei	50	154	43	1	55	151	41	5
Soroca	62	163	45	3	51	134	61	-
Centre	572	1399	446	17	518	1378	499	31
Anenii Noi	48	119	28	4	42	120	38	3
Calarasi	71	149	35	1	68	163	40	2
Criuleni	33	119	26	1	45	126	55	2
Dubasari	13	53	15	-	12	40	16	1
Hincesti	95	194	48	2	107	231	38	4
Ialoveni	40	140	42	4	43	127	27	1
Nisporeni	61	109	23	4	57	133	25	4
Orhei	90	270	55	4	90	226	60	1
Rezina	26	98	25	3	45	94	22	-
Straseni	59	156	34	4	58	136	49	3
Soldanesti	42	103	24	-	29	91	24	1
Telenesti	65	154	23	1	49	123	32	1
Ungheni	81	231	57	3	76	222	62	6
South	375	914	204	7	361	907	238	14
Basarabasca	16	40	10	1	20	38	13	-
Cahul	100	210	53	1	87	225	68	3
Cantemir	72	181	33	-	70	182	41	2
Causeni	46	120	28	-	40	116	32	2
Cimislia	43	94	19	1	48	84	18	1
Leova	47	115	18	1	47	118	22	2
Stefan Voda	38	94	31	2	35	107	19	3
Taraclia	13	60	12	1	14	37	25	1
TAU Gagauzia	83	178	48	3	59	208	69	6

¹ Including some localities from the left side of Nistru and municipality of Bender

FERTILITY

3.9. Female fertility by age group

live births per 1000 women of the respective age

Age group, years	2006		2007	
	Urban	Rural	Urban	Rural
Total 15-49	30,07	42,68	29,9	44,7
15-19	16,87	36,85	14,5	34,9
20-24	61,06	107,76	51,2	126,4
25-29	68,83	73,82	65,3	80,5
30-34	39,96	39,98	43,5	42,2
35-39	16,07	15,96	17,7	16,3
40-44	2,20	3,07	2,5	3,0
45-49	0,01	0,04	0,1	0,1

3.10. Total fertility rate by area of residence for 2003-2007

(average number of children born by a woman during her fertile life)

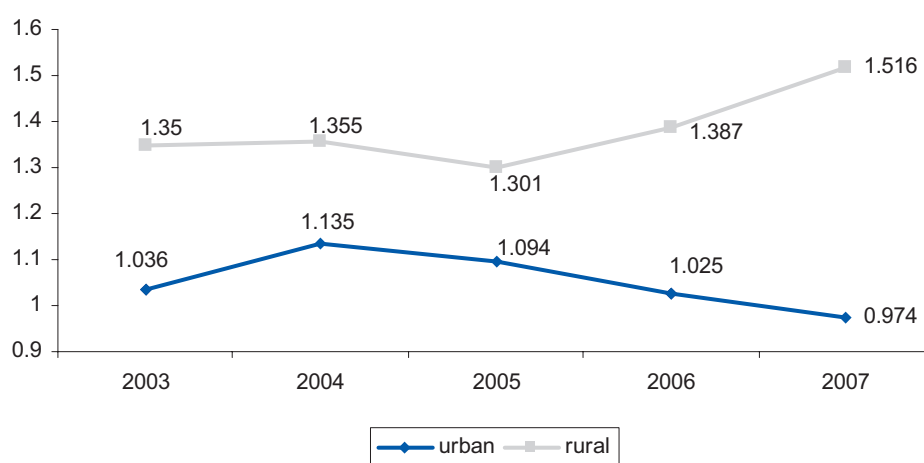

At the level of total fertility rate (15-49 years old) a slight decrease is noticed in urban area for 2007 as compared to 2006 and a slight increase in rural area. This tendency seems to remain for the entire period 2003 – 2007. In urban area, beginning with 2004 the total fertility rate started to decrease, from 1,135 in 2004 to 0,974 in 2007 (less than one child for each woman of fertile age). However, in the rural area, total fertility rate is increasing, from 1,301 in 2005 to 1,516 in 2007.

3.11. Pregnancy interruptions by type and age group

persons

Type	2006					2007				
	Total	Age group, years:				Total	Age group, years:			
		under15	15-19	20-34	35 +		under15	15-19	20-34	35 +
Total	15742	18	1410	11884	2430	15843	19	1409	11954	2461
mini-abortions	5468	2	500	4125	841	5635	4	453	4158	1020
spontaneous	4381	4	377	3394	606	4055	5	380	3108	562
artificial (legal)	4749	3	428	3530	788	5255	3	491	4000	761
artificial, medical	1097	9	102	802	184	858	7	83	651	117
illegal pregnancy interruptions	2	-	-	1	1	11	-	-	10	1
unspecified	45	-	3	32	10	29	-	2	27	-

In 2007 the number of pregnancy interruptions slightly increased compared to 2006. Over 75% of them were in women from the age group 20-34 years old. In both years more than 30% of the pregnancy interruptions were artificial, performed on request. Whether in 2006 there were only 2 illegal pregnancy interruptions, then in 2007 their number increased by almost 6 times, reaching 11.

Annually, approximately 5.000 women from the Republic of Moldova see abortion as a unique and last contraception mean. Moreover, although during the last year there is a tendency of births in couples who decided to not register officially their marriages, it is most probable that part of the high number of children born outside marriage is from unplanned births. In 2007 there were approximately 8500 births outside marriage⁵, of them 1802 births by women under 20 years old⁶. In this sense, in order to formulate more clear conclusions, specific researches on this theme are needed.

3.12. Use of contraception means

persons

Name of the contraception means	2006	2007
Intrauterine devices	12259	12429
Combined oral contraceptives, total	66676	31773
of them:		
monophasic oral	61193	29707
triphasic oral	5483	2066
Injectable (Depo-Provera)	1217	1215
Condoms	436357	483297
Mini pills	12008	8903
Voluntary surgical sterilization of women	271	404

In 2006, a number of 528.788 women used at least a contraception mean and in 2007 their number was of 538.021 women. Condom is the most often used contraception mean (83% in 2006 and almost 90% in 2007 from the total of women reporting they used a contraception mean). It is noticed a decrease by more than a half of the number of women using combined oral contraceptives in 2007 and a decrease by almost 26% of the number of women using mini pills.

GENERAL MORTALITY

3.13. General mortality rates by age group

deceased per 1000 persons of the respective sex and age

Age group, years	2006				2007			
	Urban		Rural		Urban		Rural	
	W	M	W	M	W	M	W	M
Total	8,2	10,5	13,1	14,9	8,3	10,6	13,3	14,5
0-4	2,8	3,3	2,5	3,0	2,3	2,7	3,1	3,0
5-9	0,3	0,4	0,2	0,5	0,1	0,3	0,2	0,4
10-14	0,2	0,3	0,4	0,5	0,2	0,3	0,2	0,5
15-19	0,3	0,8	0,4	0,9	0,4	0,7	0,6	0,9
20-24	0,3	0,9	0,5	1,3	0,5	1,0	0,5	1,8
25-29	0,4	2,2	0,8	2,0	0,6	1,9	0,9	2,0
30-34	1,0	3,2	1,2	3,3	1,0	3,1	1,3	3,5
35-39	1,5	4,1	1,8	6,6	1,8	4,5	1,8	5,0
40-44	2,4	6,6	3,7	9,5	2,0	6,6	3,0	8,9
45-49	3,8	10,9	5,4	14,5	3,5	11,6	5,3	13,1
50-54	6,4	15,9	8,7	20,8	5,6	15,1	8,6	19,1
55-59	10,4	21,8	15,0	27,4	10,7	24,1	15,1	28,3
60-64	16,6	27,6	23,8	38,5	14,3	27,8	18,9	32,5
65-69	23,5	44,8	33,1	58,4	26,4	47,0	33,1	55,4
70-74	45,7	66,4	51,5	76,2	39,1	66,3	51,9	73,0
75-79	68,5	93,3	81,9	114,4	65,4	94,1	80,4	103,5
80-84	100,4	128,8	122,3	154,4	114,3	124,6	121,2	138,0
85 and over	165,6	183,3	232,5	266,3	189,7	173,6	194,3	217,3

⁵ See the table 3.1 Number of live births

⁶ See table 3.8 Number of live-births outside marriage in territorial aspect

3.14. Mortality rates by age and sex in 2007

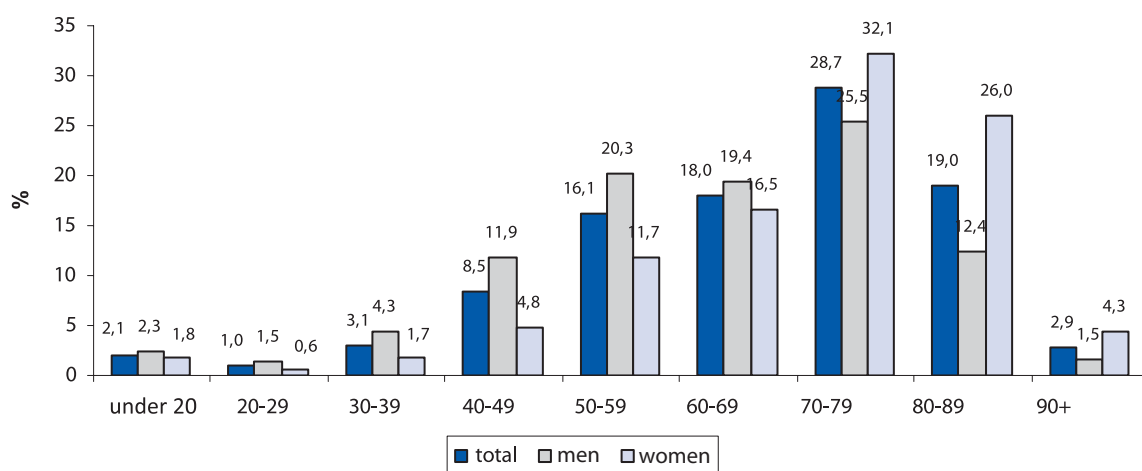

Although more boys than girls are born, female mortality rates are lower than those of male mortality rates for the age groups up to 70 years old, after which the rates reverse. Whether for the age groups under 20 years old, 20-29 years old and 30-39 years old the differences are not big (0,5% for the age group 20 years old, 0,9% for the age group 20-29 and 2,6% for the age group 30-39), starting with the age group 40-49 years old, the difference increases: 7,1% for the age group 40-49, 8,6% for the age group 50-59 and 2,9% for 60-69 years old. For the age group over 70 years old, female mortality rate is higher than male mortality rate (from a difference of 6,6% for the age group 70-79 to 13,6% for the age group 80-89). However this is natural, as women represent 62,5% of the population over 65 years old.

Generally, mortality for all age groups is higher in rural area than in urban area, regardless of sex.

3.15. Deceased by main causes of death

number of deceased persons per 100000 inhabitants

Death cause	2006				2007			
	Urban		Rural		Urban		Rural	
	W	M	W	M	W	M	W	M
Total	821.9	1046.6	1308.8	1490.2	822.5	1038.4	1333.4	1475.5
of them:								
Infectious and parasitic diseases	6.5	37.6	8.2	33.1	9.7	35.2	7.6	33.7
Tumours	135.3	169.3	124.4	187.5	139.2	175.7	124.8	177.0
Diseases of the circulatory system	489.8	478.9	856.3	745.5	501.6	484.3	878.6	729.5
Diseases of the respiratory system	28.9	59.9	63.0	126.2	23.5	60.3	67.6	122.4
Diseases of the digestive system	81.1	96.8	139.6	153.8	69.5	97.3	144.8	146.3
Diseases of the nervous system and sense organs	4.1	12.7	7.0	16.9	5.5	16.1	8.5	22.2
Accidents, intoxications and traumas	37.7	135.6	55.6	188.5	39.8	122.1	53.1	187.4

3.16. Deceased by main causes of death in 2007

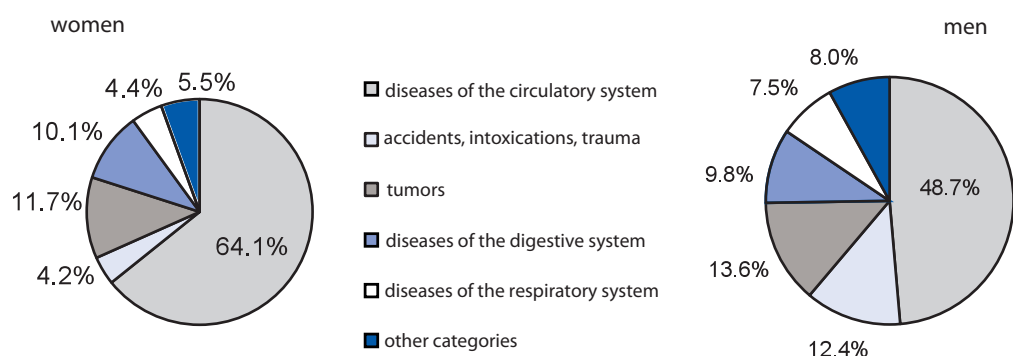

More men than women die every year in the Republic of Moldova. The most significant gender differences regarding death causes occur with regard to the category of accidents, intoxications and traumas, where, in 2006 about 77,6% of the number of deceased per 100.000 inhabitants were men and in 2007 the percentage reached also approximately 77%.

The diseases of the circulatory system represent the main cause of death both in case of women (64% of deaths) and in case of men (about 49%). Actually, the diseases of the circulatory system are the only death cause in case of which the share of deceases among women is higher than among men.

However, this is also valid when referring to the total number of deaths per 100.000 inhabitants. When talking about deceased persons of working age⁷, number of men continues to be higher than that of women in all categories of death causes.

3.17. Mortality as a result of female and male genital cancer

	2006		2007	
	Urban	Rural	Urban	Rural
Number of women deceased as a result of female genital cancer	189	264	156	225
Rate per 100000 women	24.39	24.21	19.93	20.93
Number of men deceased as a result of male genital cancer	71	83	71	89
Rate per 100000 men	10.04	8.18	10.22	8.68

3.18. Mortality as a result of female and male genital cancer, 2003-2007

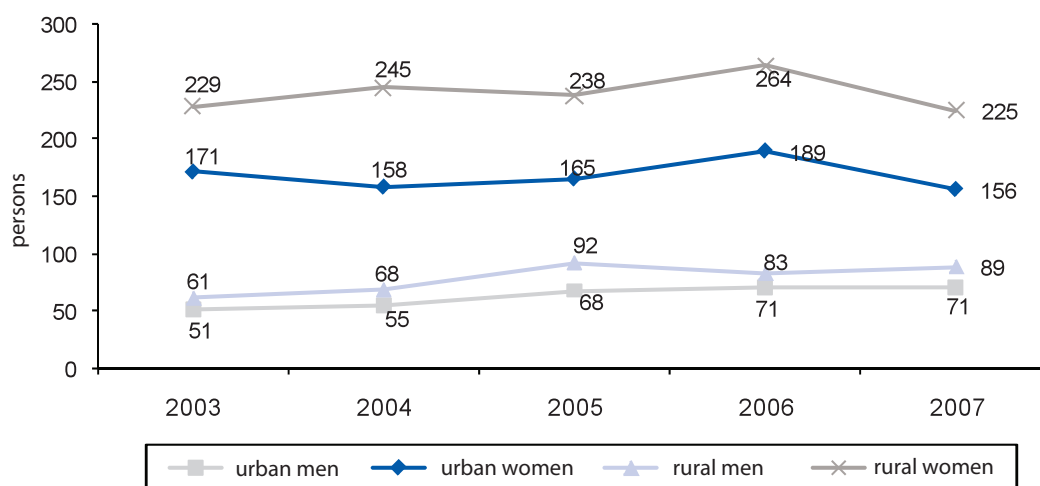

Although the mortality rate as a result of female genital cancer is almost double compared to mortality rate caused by male genital cancer, there is noticed a tendency of slight decrease with regard to female mortality rate and slight increase in male mortality rate in the period 2003 – 2007, both in urban and rural areas.

⁷ See table 3.19 Deceased persons of working age by main cause of death

3.19. Deceased persons of working age by main death cause

number of deceased persons per 100000 inhabitants

Death cause	2006				2007			
	Urban		Rural		Urban		Rural	
	W	M	W	M	W	M	W	M
Total	257,2	695,7	350,8	882,0	211,9	646,8	321,5	883,6
of them:								
Infectious and parasitic diseases	6,9	48,1	10,9	45,2	10,0	44,2	10,4	45,4
Tumours	69,4	105,8	71,3	136,0	66,0	105,2	66,1	121,5
Diseases of the circulatory system	53,9	174,8	77,7	208,9	47,2	187,7	77,3	221,7
Diseases of the respiratory system	9,1	41,7	14,5	70,9	6,8	42,4	12,5	70,2
Diseases of the digestive system	39,4	89,0	76,9	134,5	34,8	84,3	82,4	135,5
Diseases of the nervous system and sense organs	3,4	11,6	7,5	17,7	3,8	18,4	8,0	26,4
Accidents, intoxications and traumas	29,7	144,4	46,1	225,2	30,8	133,2	46,0	222,4

3.20. Mortality as a result of homicide

persons

Age group, years	2006				2007			
	Urban		Rural		Urban		Rural	
	W	M	W	M	W	M	W	M
Total	23	63	56	121	22	55	69	100
under 20	3	3	2	5	-	7	4	9
20-29	1	16	8	17	5	10	4	12
30-39	2	8	10	28	1	7	14	16
40-49	3	13	15	31	1	13	18	24
50-59	8	14	6	27	4	15	12	15
60 +	6	9	15	13	11	3	17	14

3.21. Structure of mortality as a result of homicide, by sex, 2003-2007, in %

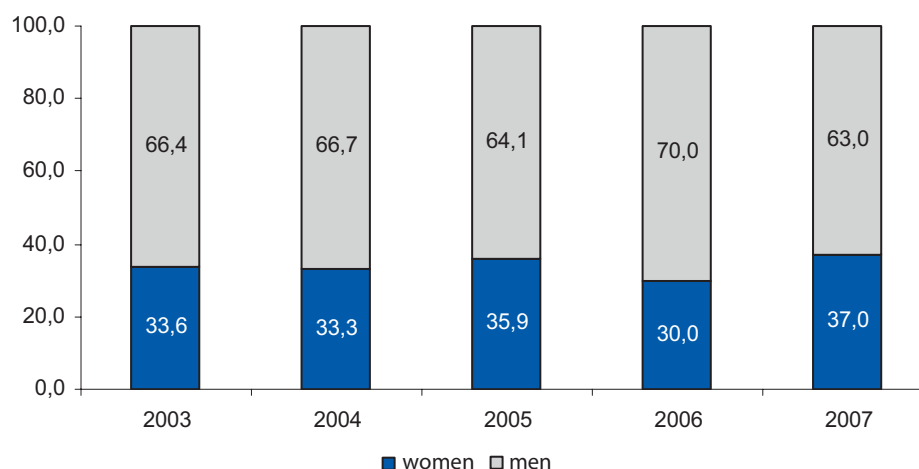

More men than women are killed every year by their fellows. During 2003-2007 about 30-37% of the victims of homicide were women, while men represented about 63-70% of the victims. There are more victims of homicide in rural area than urban area, both among women and men. The only age group where more victims were women than men is that over 60 years old, especially in rural area. The differences between women and men are not big, yet they prove once more the increased vulnerability of aged women from the rural area.

3.22. Mortality as a result of suicide

persons

Age group, years	2006				2007			
	Urban		Rural		Urban		Rural	
	W	M	W	M	W	M	W	M
Total	37	159	59	382	34	117	46	365
under 20	-	6	6	9	3	4	3	14
20-29	3	21	2	29	2	12	2	40
30-39	7	21	6	65	7	24	10	49
40-49	6	43	11	106	6	36	9	109
50-59	17	35	13	107	5	22	11	98
60 +	4	33	21	66	11	19	11	55

3.23. Number of suicides by sex and age, 2007

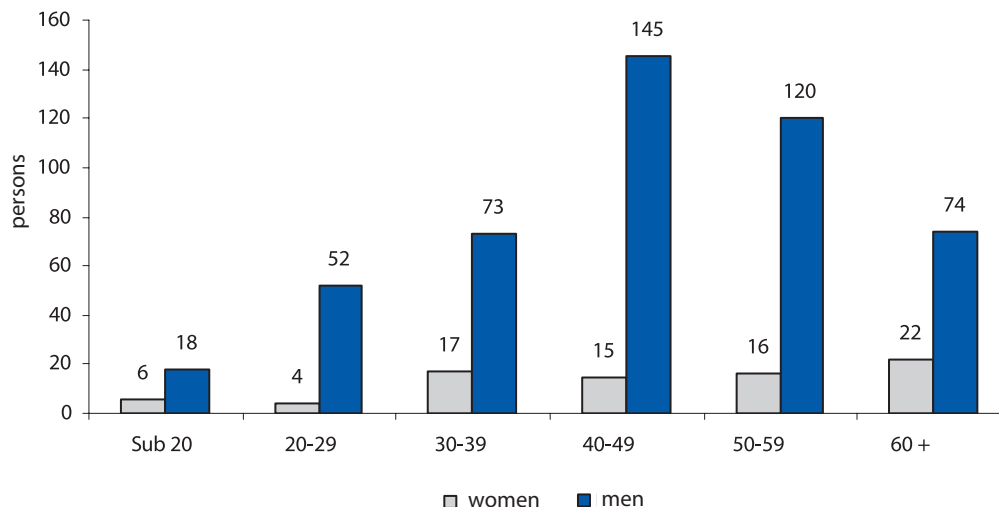

In 2006 and 2007 over 85% of the total of suicides were registered among men. It is noticed a slight decrease of the number of suicides in 2007 compared to 2006 among both women and men, and regardless of their area of residence. Regarding the age group of those committing suicide, the number of suicides among women varies slightly, while the highest number of suicides among men occurs in the age group of 40-49 and 50-59.

3.24. Number of deceased in territorial aspect, 2007

ATU	Persons				Per 100000 inhabitants			
	Urban		Rural		Urban		Rural	
	F	B	F	B	F	B	F	B
Total	6476	7379	14336	14859	8,3	10,6	13,3	14,5
Mun. Chisinau	2741	3139	296	379	7,2	9,4	8,5	11,3
North	1765	1958	5423	5218	9,3	11,7	15,7	16,4
mun. Bălți	716	748	22	23	9,3	11,4	8,6	9,9
Briceni	85	111	537	495	10,4	15,1	16,7	17,0
Dondușeni	58	51	344	351	10,0	10,3	18,0	20,9
Drochia	98	112	612	552	9,1	11,5	16,4	16,2
Edineț	147	160	521	488	10,6	13,2	17,0	17,7
Fălești	82	106	566	559	8,8	12,4	14,5	15,1
Florești	101	125	604	592	10,0	13,8	16,1	17,0
Glodeni	51	59	407	394	8,2	10,4	15,3	16,0
Ocnița	97	97	346	318	9,4	10,5	17,4	18,0
Rîșcani	80	74	479	465	9,5	9,7	16,6	17,4
Sîngerei	92	99	437	434	9,4	11,0	11,3	11,8
Soroca	158	216	548	547	8,3	11,8	16,5	17,7

ATU	Persons				Per 100000 inhabitants			
	Urban		Rural		Urban		Rural	
	F	B	F	B	F	B	F	B
Centre	950	1123	5444	5897	8,8	11,5	12,4	13,9
Anenii Noi	54	37	414	464	11,7	9,3	10,9	12,7
Călărași	69	103	473	547	8,1	13,3	14,7	17,4
Criuleni	40	49	390	463	9,1	12,1	11,9	14,7
Dubăsari	-	-	264	232	-	-	14,7	13,4
Hîncești	82	111	621	739	9,1	13,9	11,6	13,9
Ialoveni	62	83	451	468	8,1	11,5	10,8	11,4
Nisporeni	66	80	344	305	8,6	11,0	13,0	11,7
Orhei	174	188	609	626	9,7	12,1	12,7	13,9
Rezina	62	84	299	319	9,0	12,7	14,8	16,3
Strășeni	112	126	436	464	10,2	12,0	12,3	13,5
Șoldănești	34	36	295	299	8,6	9,9	15,7	16,6
Telenești	38	38	364	423	8,7	9,6	10,8	12,7
Ungheni	157	188	484	548	7,2	10,0	12,3	14,7
South	655	767	2603	2701	9,2	11,7	12,6	13,4
Basarabeasca	79	102	96	111	12,0	17,0	11,1	13,4
Cahul	157	184	501	513	7,5	10,2	11,6	12,3
Cantemir	13	10	358	348	4,1	3,5	12,5	12,0
Căușeni	138	152	481	526	10,8	12,6	13,8	15,6
Cimișlia	61	77	303	340	8,1	11,0	12,3	14,1
Leova	90	102	218	231	11,3	12,9	11,4	12,1
Ștefan Vodă	32	46	426	422	7,1	10,7	13,2	13,3
Taraclia	85	94	220	210	10,9	13,0	14,5	14,5
U.T.A. Găgăuzia	355	385	564	657	10,4	12,6	11,5	14,3

MATERNAL MORTALITY AND MORTALITY IN CHILDREN OF 0-4 YEARS OLD

3.25. Maternal mortality

	2006		2007	
	Urban	Rural	Urban	Rural
Number of women deceased because of pregnancy, delivery and post-delivery complications	3	3	3	3
Rates per 100000 live births	22,1	12,5	21,9	12,3

3.26. Maternal mortality by area of residence, 2003-2007

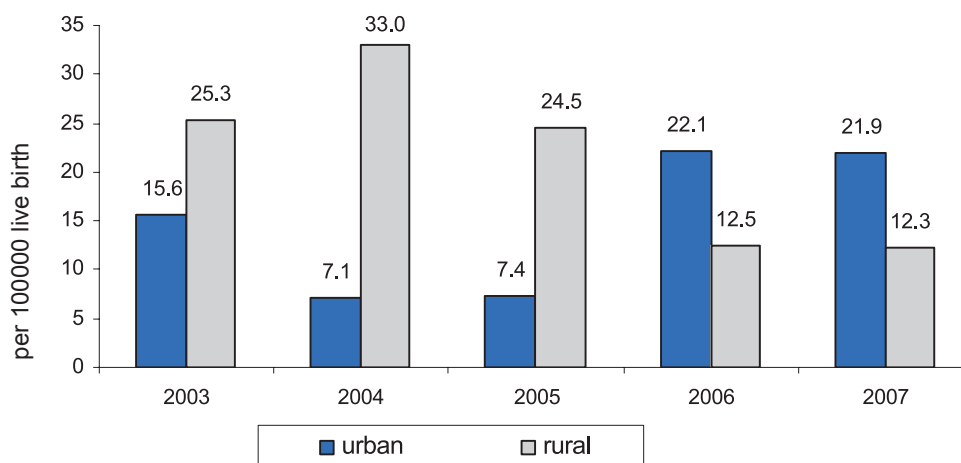

Improvement of maternal health is the 5th Millennium Development Goal, and in this context, the targets to be reached by the Republic of Moldova refer to reduction of maternal mortality rate from 16 deaths per 1000 live births in 2006 to 15,5 by 2010 and 13,3 by 2015.⁸

It is interesting to notice that in the period 2003-2007 the maternal mortality rates in urban and rural areas reversed: if between 2003-2005 maternal mortality rates in rural area were higher than in urban area, the biggest difference being in 2004 (33 women deceased per 100.000 live births in rural area, compared to only 7,1 deceases in urban area), in 2006 and 2007 maternal mortality rates in urban area were higher than those from rural area.

Although the number of deceased women because of pregnancy, delivery and post-delivery complications is the same in both urban and rural area, due to the fact that maternal mortality rate is measured depending on the number of deaths per 100.000 live births, and the number of births in rural area is higher than that in urban area, we get higher mortality rates in urban area than in rural area.

3.27. Infant mortality

	2006				2007			
	Urban		Rural		Urban		Rural	
	W	M	W	M	W	M	W	M
Number of children deceased under 1 year of age	78	99	121	144	62	79	147	142
Rates per 1000 live births	11,7	14,3	10,4	11,6	9,4	11,3	12,3	11,3

3.28. Infant mortality rate by area of residence, 2003-2007

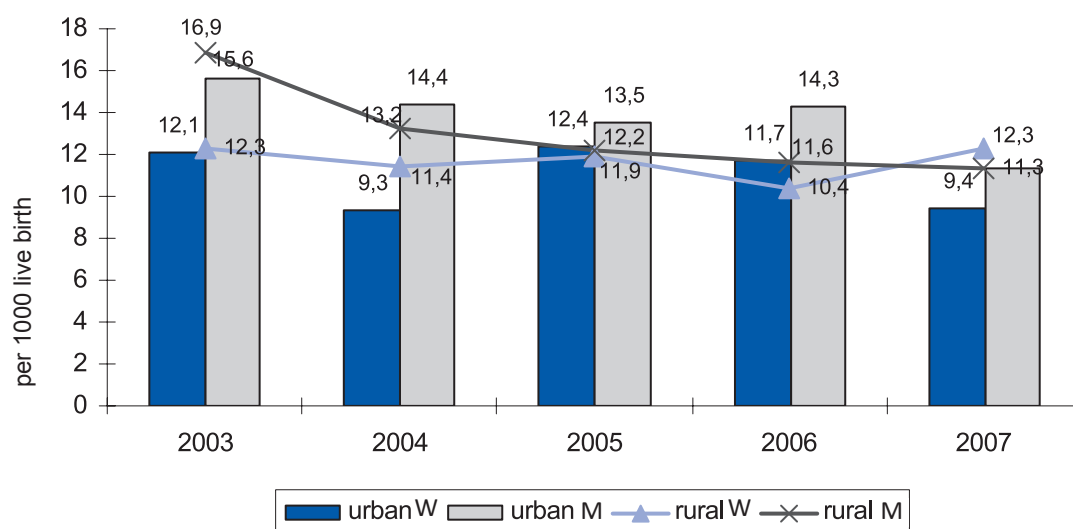

Reduction of child mortality is the 4th Millennium Development Goal. From the presented data, it could be noticed a slight decrease in the number of children under 1 year deceased in 2007 compared to 2006 in urban area, yet, at the same time, we assist to a slight increase of the number of deceased children under 1 year of age in rural area. Only in the rural area in 2007 were registered more deceases in case of girls under 1 year of age.

⁸ Although maternal mortality described in the national targets for the Republic of Moldova referring to MDG 5 is calculated as the number of deceases registered per 1.000 live births, in this study the maternal mortality rates are calculated per 100.000 live births.

3.29. Infant mortality by death causes

persons

	2006				2007			
	Urban		Rural		Urban		Rural	
	W	M	W	M	W	M	W	M
Total deceased under 1 year of age	78	99	121	144	62	79	147	142
of them, by death causes:								
Infectious and parasitic diseases	2	1	6	5	1	-	5	8
Diseases of the nervous system and sense organs	1	1	2	3	-	-	2	-
Diseases of the respiratory system	15	16	30	20	12	12	23	21
Diseases of the digestive system	1	-	-	1	-	-	1	1
Congenital anomalies	19	31	39	45	12	12	41	43
Conditions occurring in the pre-delivery period	18	30	42	57	16	30	47	56
Accidents, intoxications and traumas	4	1	8	21	7	7	25	22

3.30. Deceased under 1 year of age, by main death causes, 2003-2007

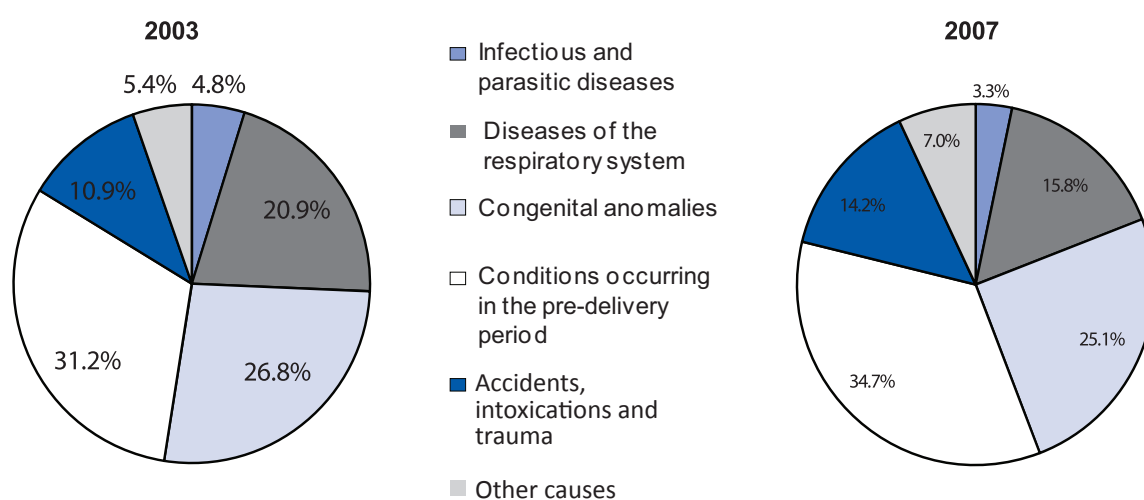

The share of death causes in case of children deceased under 1 year of age remained the same for the period 2003-2007, the main cause being conditions that occurred in pre-delivery period, congenital anomalies, diseases of the respiratory system and accidents, intoxications and traumas. The infectious and parasitic diseases always had relatively small share (under 5% of the cases) and in 2007 their share decreased to 3,3%.

3.31. Child mortality in age group 0 – 4 years old by death cause

persons

	2006				2007			
	Urban		Rural		Urban		Rural	
	W	M	W	M	W	M	W	M
Total deceased between 0-4 years old	89	114	145	179	74	96	177	184
of them, by death causes:								
Infectious and parasitic diseases	1	3	9	5	1	-	8	11
Diseases of the nervous system and sense organs	1	5	2	5	-	2	2	5
Diseases of the respiratory system	15	14	34	23	14	15	29	25
Diseases of the digestive system	1	-	-	1	1	-	1	1
Congenital anomalies	33	20	52	45	16	15	46	50
Conditions occurring in the pre-delivery period	30	18	57	42	16	30	47	56
Accidents, intoxications and traumas	7	3	17	40	14	11	40	40

3.32. Mortality rate in children of 0-4 years old by area of residence, in 2003-2007

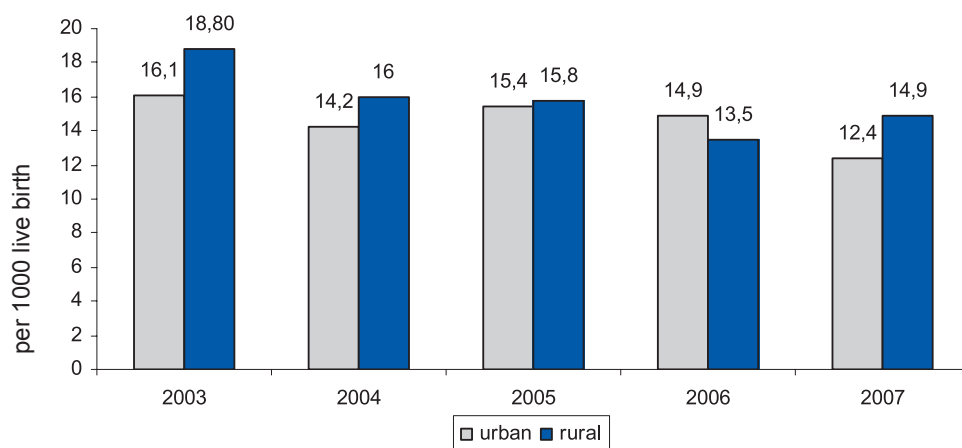

Also more boys than girls died in 2006 and 2007 in the age group 0-4 years old, regardless of the area of residence. Mortality rate in children of 0-4 years old had a continuous decrease from 2003 till 2007, generally being higher in rural area compared to urban area. An exception is 2006 when things reversed, yet the difference was of only 1.4 deceases per 1.000 live births.

MARRIAGES AND DIVORCES

3.33. Marriages and divorces

	2006		2007	
	Urban	Rural	Urban	Rural
Number of marriages	13174	13954	14622	14591
Number of divorces	9652	2942	11003	2920
Marriage rate per 1000 inhabitants	8.9	6.6	9.9	7.0
Divorce rate per 1000 inhabitants	6.5	1.4	7.5	1.4

3.34. Marriage and divorce rates, in 2003-2007

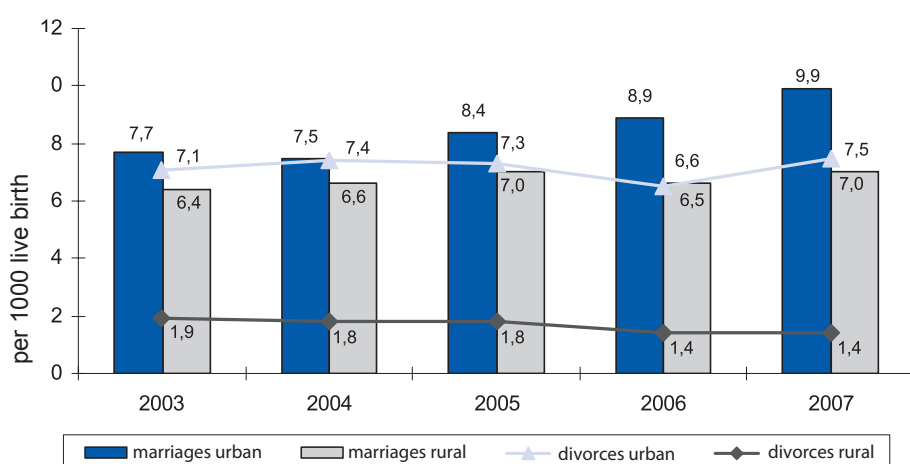

A short analysis of marriage and divorce rates show that both in 2006 and 2007 the number of marriages and divorces was higher in urban area than in rural area. If, however, the differences in terms of the number of marriages concluded in urban area and rural area are not very big, then regarding divorces, the difference is significant. A factor favouring this situation is obviously a better access to a legal representative (lawyer)

and justice in the urban area compared to the rural area. However, in-depths gender analysis is needed to see whether the traditional mentality on establishment and keeping a family by any means and patriarchal gender relations in rural area has the same influence as in the urban area, where traditional gender relations suffered a certain change.

3.35. Marriages by the age of spouses

Age group, years	2006				2007			
	Urban		Rural		Urban		Rural	
	W	M	W	M	W	M	W	M
Total	13174	13174	13954	13954	14622	14622	14591	14591
under 20	1464	271	3406	513	1441	291	3282	530
20-29	8769	8366	8613	10343	9787	9244	9147	10617
30-39	1692	2691	1099	1963	2039	3052	1279	2253
40-49	827	1101	530	691	851	1203	551	711
50-59	346	530	242	307	423	629	254	344
60+	76	215	64	137	81	203	78	136

3.36. Marriages by age and previous civil status of spouses in 2007

Age group, years	Never married before		Widowed		Divorced	
	W	M	W	M	W	M
Total	23972	23377	532	322	4684	5503
under 20	4683	818	0	0	37	3
20-29	17519	18927	45	10	1350	921
30-39	1430	3116	119	27	1769	2159
40-49	230	386	160	68	1011	1459
50-59	82	96	146	103	448	772
60+	28	34	62	114	69	189

More women than men get married earlier, over 85% of people under 20 years old which got married in 2007. This means that more women than men drop out continuation of education and/or enter earlier the labour market devoting themselves to establishment of a family. Of course, the differences by residence area were in favour of rural area, regardless of sex. Also, the majority of women and men from this age group which get married are at their first marriage.

However, the highest number of marriages is concluded between people from the age group 20-29 years old, both in case of women and men, regardless of area of residence. However, in the rural area the number of men getting married is higher than that of women, while in urban area these rates reverse.

3.37. Marriages by age and previous civil status of spouses in 2007, in %

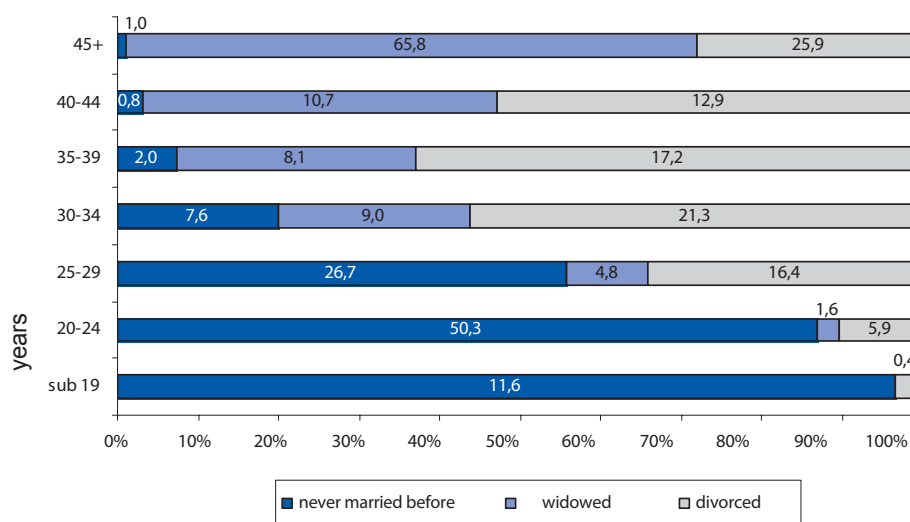

The pyramid of marriages by age and previous civil status of spouses looks as it was expected:

- For the age groups under 19 years old, 20-24 years old and 25-29 years old, the highest share is that of people at their first marriage
- For the age groups 30-34 years old, 35-39 and 40-44 years old, the highest share is held by divorced people (although in the last age group, widowed people have the same share)
- For the age group over 45 years old, the share of widowed people is the highest.

3.38. Share of first marriages in the age group 15-19 years old in the total of marriages concluded for the first time

Years	Total		Urban		Rural	
	W	M	W	M	W	M
2006	23,3	3,7	15,3	2,8	29,7	4,5
2007	20,8	3,6	13,3	2,7	27,3	4,4

Although the share of marriages of persons from the age group 15-19 years old in the total of marriages concluded for the first time is decreasing (see Table 3.39), significantly more women than men get married at this age: over 20% of the women married in 2006 and 2007 were from this age group compared to only 3,7-3,6% of men from the same age group. Differences between rural and urban area are almost double.

3.39. Share of first marriages in the age group of 15-19 years old in the total of marriages concluded for the first time by area of residence, 2003-2007

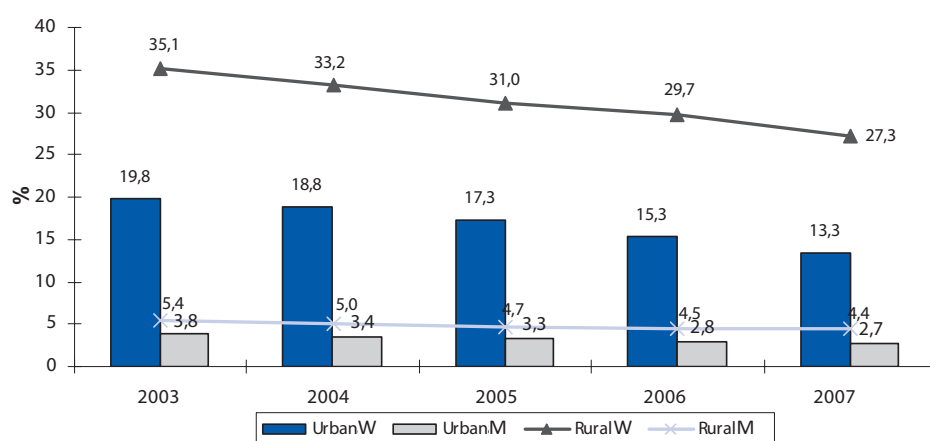

3.40. Marriages by age group of spouses in 2007

Age group of husband, years	Total	Age group of wife, years:					
		under 20	20-24	25-29	30-34	35-39	40+
Total	21563	4492	12235	3818	751	149	118
under 20	784	456	290	32	6	-	-
20-24	10411	2926	6625	776	78	5	2
25-29	7599	964	4401	2018	198	16	2
30-34	2027	128	778	764	304	44	9
35-39	471	16	110	166	122	47	10
40+	134	1	11	26	18	12	66

3.41. Marriages concluded by the nationality of spouses, in 2007

Husband's nationality	Total	Wife's nationality :							
		Moldovan	Russian	Ukrainian	Gagauz	Belarusian	Jewish	Bulgarian	other
Total									
Total	29213	22708	1583	2012	1902	54	41	570	343
Moldovan	22125	19994	705	890	168	22	23	170	153
Russian	1442	645	362	265	75	14	5	43	33
Ukrainian	1940	892	274	636	49	9	6	44	30
Gagauz	1897	187	69	66	1456	5	1	103	10
Belarusian	33	14	8	7	3	1	-	-	-
Jewish	92	59	14	10	1	-	5	1	2
Bulgarian	552	176	40	46	87	1	-	193	9
Other	1132	741	111	92	63	2	1	16	106
Urban area									
Total	14622	10223	1394	1453	861	44	39	332	276
Moldovan	9710	8031	619	684	98	19	22	113	124
Russian	1271	563	331	235	60	13	5	31	33
Ukrainian	1329	636	242	360	33	3	6	29	20
Gagauz	847	124	48	47	569	5	1	45	8
Belarusian	32	14	8	6	3	1	-	-	-
Jewish	89	58	13	9	1	-	5	1	2
Bulgarian	320	113	33	28	40	1	-	100	5
Other	1024	684	100	84	57	2	-	13	84
Rural area									
Total	14591	12485	189	559	1041	10	2	238	67
Moldovan	12415	11963	86	206	70	3	1	57	29
Russian	171	82	31	30	15	1	-	12	-
Ukrainian	611	256	32	276	16	6	-	15	10
Gagauz	1050	63	21	19	887	-	-	58	2
Belarusian	1	-	-	1	-	-	-	-	-
Jewish	3	1	1	1	-	-	-	-	-
Bulgarian	232	63	7	18	47	-	-	93	4
Other	108	57	11	8	6	-	1	3	22

The highest number of marriages concluded in 2007 was between spouses of the same nationality (Moldovan), at their first marriage. Nevertheless, it is noticed a slight increase in the number of marriages concluded between partners at their second, third, fourth and more marriages as compared to 2006, both in urban and rural areas (although the difference between the area of residence reverse when talking about third marriage or more – see Table 3.42)

3.42. Marriages by the number of marriages concluded

Rank of marriage	2006				2007			
	Urban		Rural		Urban		Rural	
	W	M	W	M	W	M	W	M
Total marriages	13174	13174	13954	13954	14622	14622	14591	14591
of them:								
first	10351	9918	12032	11813	11425	11066	12547	12311
second	2669	3080	1821	2024	2744	3100	1886	2157
third	140	165	85	106	400	415	125	107
fourth and more	14	11	16	11	53	41	33	16

3.43. Divorces by the nationality of spouses

Husband's nationality	Total	Wife's nationality:							
		Moldovan	Russian	Ukrainian	Gagauz	Belarusian	Jewish	Bulgarian	other
2006									
Total	12594	6869	640	751	716	18	7	177	3416
Moldovan	6149	5142	134	238	59	9	2	36	529
Russian	674	192	254	100	34	-	-	12	82
Ukrainian	673	270	73	218	27	3	2	11	69
Gagauz	671	66	22	18	497	-	-	33	35
Belarusian	20	7	3	4	1	-	-	1	4
Jewish	26	11	6	2	-	1	1	-	5
Bulgarian	162	36	11	8	25	-	-	64	18
Other	4219	1145	137	163	73	5	2	20	2674
2007									
Total	13923	7110	726	880	667	18	17	172	4333
Moldovan	6344	5213	192	267	38	6	8	21	599
Russian	664	223	215	99	12	2	-	14	99
Ukrainian	844	301	113	297	17	4	4	16	92
Gagauz	524	36	19	13	311	2	-	26	117
Belarusian	14	2	3	3	2	-	-	-	4
Jewish	31	10	6	5	1	-	1	2	6
Bulgarian	128	39	15	8	14	1	1	34	16
Other	5374	1286	163	188	272	3	3	59	3400

3.44. Divorces by duration of marriage and age group in 2007

Age group, years	Total divorces	of them, duration of marriage, years								
		under 1	1	2	3	4	5-9	10-14	15-19	20 +
Women										
Total	13923	735	974	869	864	717	2768	2391	1872	2733
under20	163	66	62	27	8	-	-	-	-	-
20-29	4866	440	618	600	633	524	1722	329	-	-
30-39	4381	117	155	128	123	122	754	1658	1207	117
40-49	2796	68	75	64	53	35	150	243	500	1608
50-59	1132	38	38	22	27	17	60	69	74	787
60+	188	2	4	4	8	1	13	22	14	120
not stated	397	4	22	24	12	18	69	70	77	101
Men										
Total	13923	735	974	869	864	717	2768	2391	1872	2733
under20	32	28	3	-	1	-	-	-	-	-
20-29	3267	396	577	504	488	365	900	37	-	-
30-39	5003	163	210	226	244	234	1422	1764	727	13
40-49	3362	88	102	71	70	67	265	360	947	1392
50-59	1447	40	46	26	28	24	69	109	81	1024
60+	339	12	11	13	14	6	33	33	35	182
not stated	473	8	25	29	19	21	79	88	82	122

3.45. Divorces by the number of broken marriages

Rank of divorce	2006				2007			
	Urban		Rural		Urban		Rural	
	W	B	W	M	W	M	W	M
Total divorces	9652	9652	2942	2942	11003	11003	2920	2920
of them:								
first	5317	4837	2327	2086	6350	5883	2133	1881
second	605	618	271	260	742	709	248	203
third and more	15	15	4	3	27	19	7	3
not stated	3715	4182	340	593	3884	4392	532	833

Like in the case of marriages, the majority of divorces in 2006 and 2007 occurred between partners of the same nationality (Moldovan). It is interesting to notice that in 2007 the highest number of divorces occurred in marriages that lasted for 5-9 years and, at a very small difference, in marriages that lasted more than 20 years. Approximately the same share is that of divorces in marriages of 10-14 years. When analyzing divorces from the perspective of women and men age, we notice that the majority of divorcing women are in the age group of 20-29 years old, followed closely by those from the age group 30-39 years old, while in case of men the highest number of divorces occur in the age group 30-39 years old, at a small difference after those from 40-49 and then, 20-29 years old.

Also, the table below (3.46) shows that the majority of divorces in case of families with children occur when they have only one child together (over 69% of cases), as the number of children they have together increases, the number of divorces decreases.

3.46. Divorces by the number of common children in territorial aspect in 2007

	Total divorces, with children	of them with:				Number of common children
		1 child	2 children	3 children	4 children and over	
Total ¹	4665	3226	1245	157	37	6345
Mun. Chisinau	895	718	165	9	3	1087
North	1390	974	369	41	6	1864
Mun. Balti	197	161	31	4	1	239
Briceni	126	93	28	5	-	164
Donduseni	36	25	9	1	1	54
Drochia	171	113	49	8	1	239
Edinet	31	20	11	-	-	42
Falesti	71	39	30	2	-	105
Floresti	195	142	48	4	1	254
Glodeni	92	65	27	-	-	119
Ocnita	93	75	15	3	-	114
Riscani	133	83	47	3	-	186
Singerei	89	52	30	6	1	135
Soroca	156	106	44	5	1	213
Centre	1040	670	313	45	12	1479
Anenii Noi	132	88	37	6	1	184
Calarasi	15	10	4	1	-	21
Criuleni	125	77	42	5	1	180
Dubasari	37	25	11	1	-	50
Hincesti	68	46	17	2	3	98
Ialoveni	11	9	2	-	-	13
Nisporeni	35	20	14	1	-	51
Orhei	52	30	18	4	-	78
Rezina	121	77	35	9	-	174
Straseni	192	136	49	5	2	257
Soldanesti	72	40	28	3	1	109
Telenesti	48	34	12	1	1	65
Ungheni	132	78	44	7	3	199
South	871	525	287	48	11	1292
Basarabasca	54	37	14	3	-	74
Cahul	200	129	62	8	1	281
Cantemir	114	65	40	8	1	173
Causeni	91	58	27	5	1	131
Cimislia	146	83	50	13	-	222
Leova	117	66	42	6	3	183
Stefan Voda	108	63	38	3	4	165
Taraclia	41	24	14	2	1	63
TAU Gagauzia	313	200	95	13	5	449

¹ Including some localities from the left side of river Nistru and municipality of Bender

4. HEALTH

MORBIDITY BY ACTIVE TUBERCULOSIS

4.1. Morbidity by active tuberculosis, 2003-2007

new cases per 100000 population

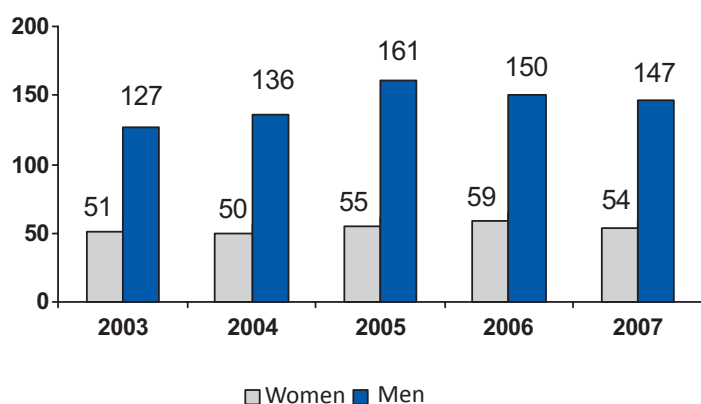

Incidence of active tuberculosis in 2007 represented 147 new cases per 100 thousand male population, being more higher than in case of women (54 new cases);

The evolution of morbidity tuberculosis incidence was not constant during the last five years, being registered an increase from 178 new cases in 2003 to 216 cases in 2005, and then occurred a decrease up to 201 cases in 2007.

Such an evolution is due to a great extent to the evolution of morbidity in men, while the morbidity registered among women has a different tendency. If in case of men the highest incidence was registered in 2005, then in case of women the tendency was increasing starting with 2004, the maximal incidence being attained in 2007 (59 new cases per 100 thousand inhabitants).

4.2. Morbidity through active tuberculosis by area of residence

persons

	2006				2007			
	Urban		Rural		Urban		Rural	
	W	M	W	M	W	M	W	M
New cases of tuberculosis - total	534	1297	567	1290	473	1114	545	1414
including:								
Active tuberculosis of the respiratory system	503	1268	526	1252	451	1093	514	1380
Tuberculosis of nervous system	2	-	1	-	-	-	-	2
Tuberculosis of other organs	29	29	40	38	22	18	29	30
Generalized tuberculosis	-	-	-	-	1	3	1	2

The lion's share in cases of morbidity through tuberculosis comes to active tuberculosis of the respiratory system, where occurred almost 97% of the total number of cases in 2007.

As for residence area, although the number of morbidity cases is higher in rural area, if referring to the number of population (higher in rural area than in urban area) it comes out that the incidence of morbidity through tuberculosis is higher in urban area. Thus, 45% of new morbidity cases registered in 2007 were in urban area, where only 41% of the population of the Republic of Moldova lives.

4.3. Morbidity through active tuberculosis by age group

persons

	2006		2007	
	W	M	W	M
New cases of tuberculosis - total	1102	2587	1018	2528
including by age group, years:				
up to 14	85	78	72	90
15-24	241	412	261	393
25-34	263	578	223	514
35-54	357	1150	296	1175
55 and over	156	369	166	356

4.4. Morbidity through active tuberculosis by age group, 2007

number of new cases per 100000 population of the respective age

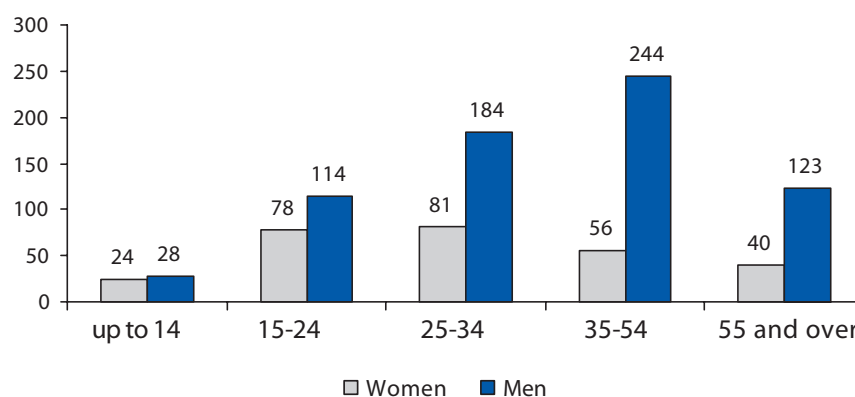

The risk of morbidity through tuberculosis is higher for the people of average age (35 – 54 years old). At the same time, morbidity of women occurs at an earlier age than men's. If to refer to it from the percentage point of view we see that the total number of morbidity among women, 7,1% of the patients were from the age group under 14 years old (compared to 3,6% in case of men) and 25,6% between 15 – 24 years old (compared to 15,5% in case of men).

MALIGNANT TUMOUR MORBIDITY

4.5. Malignant tumours morbidity, 2003-2007

number of new cases per 100000 population of the respective age

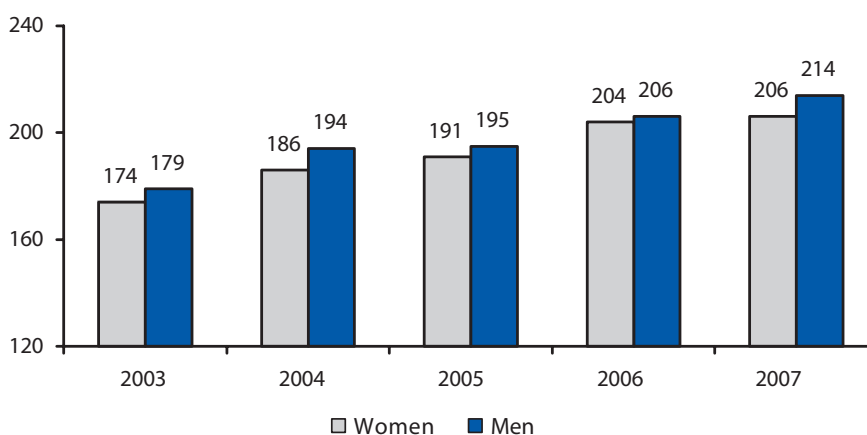

Incidence of morbidity by malignant tumours in 2007 represented 206 new cases among women and 214 among men, the difference between groups being a minor one.

Malignant tumours morbidity witnesses a constant increase during the last years. If to refer to the number of cases in 2007 compared to 2003 we notice that their incidence increased by approximately 19% for both groups.

4.6. Malignant tumours morbidity by age group and localization

persons

	Total		< 19		20-39		40-59		60 and over	
	W	M	W	M	W	M	W	M	W	M
2006										
New cases of malignant tumours	3818	3543	35	52	285	138	1606	1413	1892	1940
including that of:										
Lip, oral cavity	20	133	2	5	3	48	15	80
Tonsils, pharynx and other localizations of the oral cavity and pharynx	26	142	2	3	6	7	15	90	3	42
Lymphoid, haematopoietic and related tissues	228	199	21	28	25	28	83	76	99	67
2007										
New cases of malignant tumours	3820	3681	43	49	280	144	1574	1435	1923	2053
including that of:										
Lip, oral cavity	36	140	1	3	9	77	26	60
Tonsils, pharynx and other localizations of the oral cavity and pharynx	19	176	...	2	...	4	12	104	7	66
Lymphoid, haematopoietic and related tissues	227	247	19	25	29	44	75	85	104	93

4.7. Malignant tumours morbidity by age group, 2006-2007

persons

	2006		2007	
	W	M	W	M
Total new cases	3818	3543	3820	3681
including by age group, years				
up to 19	35	52	43	49
20-39	285	138	280	144
40-59	1606	1413	1574	1435
60 and over	1892	1940	1923	2053

More exposed to the risk of tumour morbidity are aged people and those over 40 years old, especially old people (60 years and old). As for organs affected by tumours, we see that in case of women the cases are more diversified than in case of men.

4.8. Malignant tumours morbidity specific to women, by age group

persons

	Total	< 19	20-39	40-59	60 and over
	2006				
Total new cases	1569	1	145	818	605
Mammary glands	889	-	59	483	347
Cervix	329	-	68	177	84
Uterus	215	-	4	94	117
Ovaries	136	1	14	64	57
2007					
Total new cases	1433	1	142	755	535
Mammary glands	743	-	41	394	308
Cervix	335	1	74	186	74
Uterus	219	-	11	102	106
Ovaries	136	-	16	73	47

In case of malignant tumours specific to women, a higher incidence is noticed in case of mammary glands morbidity – 743 new cases in 2007 (52% of the total), followed by cervical tumours - 335 cases or 23%;

4.9. Malignant tumours morbidity specific to men, by age group

	Total	< 19	20-39	40-59	60 and over
<i>persons</i>					
2006					
Total new cases	239	2	14	38	185
Penis	24	-	1	10	13
Prostate	196	-	-	24	172
Testicle	19	2	13	4	-
2007					
Total new cases	253	-	12	46	195
Penis	13	-	-	7	6
Prostate	222	-	-	37	185
Testicle	18	-	12	2	4

In case of tumours specific to men the highest degree of morbidity is registered in prostate tumours – 222 new cases or 87,75% of the total

At the same time it is easy to notice that tumours of testicles are registered predominantly in young age groups, thus in 12 cases from 18 morbidity cases in 2007, people were of an age between 20 and 39 years old.

ALCOHOLIC DISORDERS

4.10. Alcoholic disorders morbidity

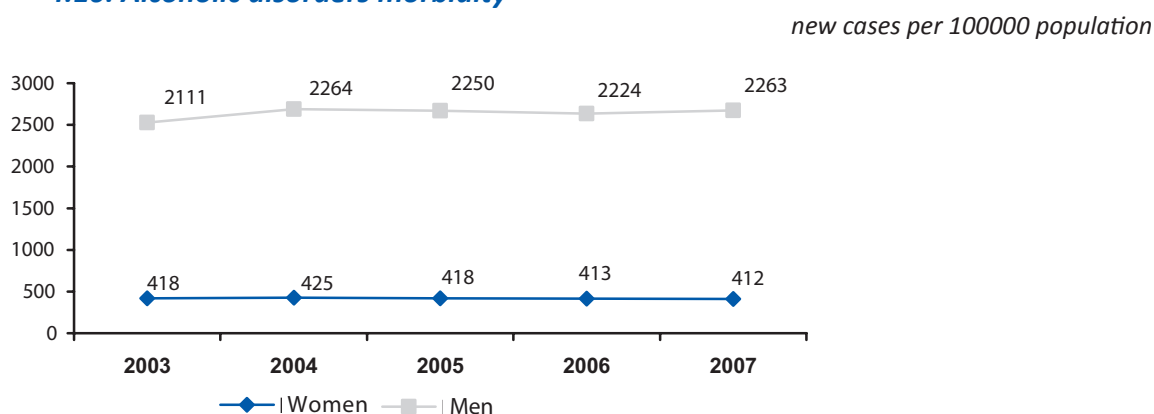

4.11. Alcoholic disorders morbidity, 2006-2007

	Total	Women	Men
<i>persons</i>			
Patients who were registered with the diagnosis - alcoholism and alcoholic psychosis - for the first time			
2006	3849	667	3182
2007	4003	614	3389
Number of patients registered at curative-prophylactic institutions: alcoholism and alcoholic psychosis, thousand persons			
2006	45,9	7,7	38,2
2007	46,5	7,6	38,9

Alcoholism is a disease specific mostly to men, in case of which incidence in 2007 was of 2263 new cases per 100 thousand population, being five times higher as compared to that among women (412 cases per 100 thousand population).

MORBIDITY BY INFECTIOUS SEXUALLY TRANSMITTED DISEASES

4.12. Morbidity of patients depending on the infections transmitted mainly sexually, by area of residence

new cases

	2006				2007			
	Urban		Rural		Urban		Rural	
	W	M	W	M	W	M	W	M
Syphilis	467	627	625	748	574	691	691	810
Gonorrhoea	198	818	224	582	170	852	211	514
Trichomoniasis	4851	1962	4702	880	5269	2292	4584	1098
Chlamydia infections	1614	925	223	119	1766	699	186	169
Ano-genital infections through herpetic virus	960	381	76	80	786	338	93	97

In 2007 there were registered about 22 thousand of new morbidity cases through sexually transmitted infections, over 800 cases more than in the previous year.

The incidence of sexually transmitted infections has specific features both by gender and area of residence. Infections with a higher incidence among women compared to men are trichomoniasis, Chlamydia virus and also anogenital infections through herpetic virus. Men get infected more often than women by gonorrhoea and syphilis.

As for area of residence, generally we remark first the much higher incidence of sexually transmitted infections in urban area. Thus, from the total number of new morbidity cases in 2007, 61% were registered in urban area. In rural area compared to urban area cases of infections with trichomoniasis occur more often - 67% of the total number of new cases in rural area compared to 56% in urban area, and infections with syphilis – 18%, respectively compared to 9%.

Another important finding is that the high incidence of infection types like Chlamydia and anogenital infections through herpetic virus occurs more often in women from urban area compared to the rural area. Moreover, in rural area their incidence among women is not very different than that in case of men.

4.13. Distribution of infected persons depending on the infections transmitted mainly sexually, by sex and age

	Total		< 14		15-19		20-39		40 and over	
	W	M	W	M	W	M	W	M	W	M
2006										
New cases	13940	7122	43	16	2716	943	9174	5122	2007	1041
including:										
Syphilis	1092	1375	5	12	191	126	673	923	223	314
Gonorrhoea	422	1400	8	1	99	230	241	1086	74	83
Trichomoniasis	9553	2842	27	1	1961	457	6262	1969	1303	415
Chlamydia Infections	1837	1044	200	51	1395	837	242	156
Anogenital infections through herpetic virus	1036	461	3	2	265	79	603	307	165	73
2007										
New cases	14330	7560	41	22	2649	1084	9537	5382	2103	1072
including:										
Syphilis	1265	1501	7	10	219	133	796	1044	243	314
Gonorrhoea	381	1366	8	3	79	186	242	1091	52	86
Trichomoniasis	9853	3390	17	...	2001	616	6392	2311	1443	463
Chlamydia Infections	1952	868	189	77	1559	632	204	159
Anogenital infections through herpetic virus	879	435	9	9	161	72	548	304	161	50

The most exposed to the risk of morbidity are both men and women of age between 20 and 39 years old. In 2007 these generations were responsible of 66% of the total number of new cases among women and 71% in case of men.

4.14. Gonorrhoea morbidity

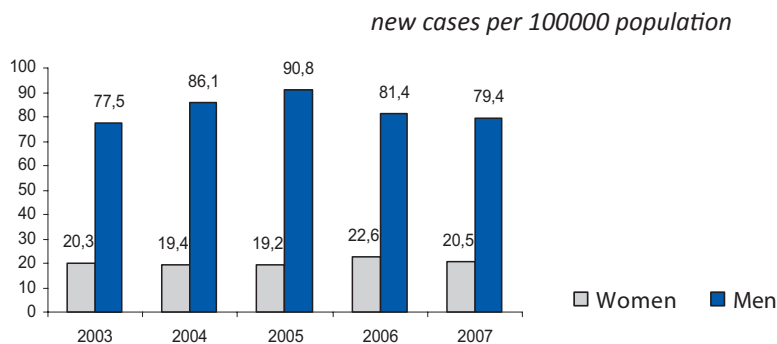

4.15. Syphilis morbidity

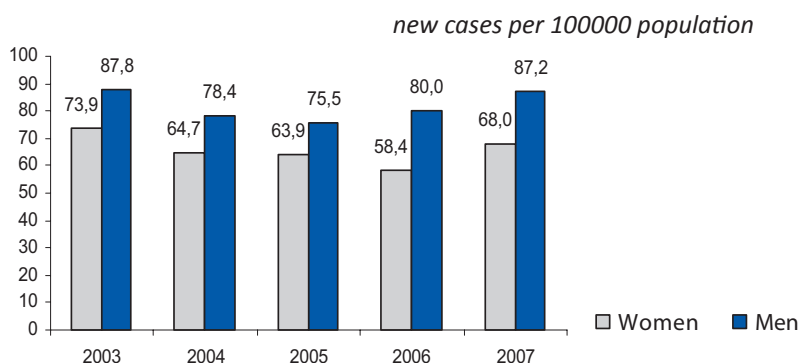

The evolution of morbidity by gonorrhoea during the last 5 years did not have a unitary tendency, being registered both increases and decreases of the incidence. At the same time, the evolution of this indicator among women did not follow a trend similar to that among men. Thus, among men until 2005 there followed an increase up to 90,8 new cases per 100 thousand inhabitants, then a decrease. For women, until 2005 the tendency was a decreasing one, then a sharp increase, the maximal incidence being registered in 2006 (22,6 new cases per 100 thousand inhabitants), and in 2007 again a decrease up to 20,5 cases per 100 thousand inhabitants.

As far as syphilis morbidity concerns, the trends among women had directions almost similar to those of men. However, the evolution is reversed to that in case of gonorrhoea, the morbidity following a decrease towards 2005 and 2006, then again an increasing trend was registered.

4.16. Syphilis morbidity by age group, 2007

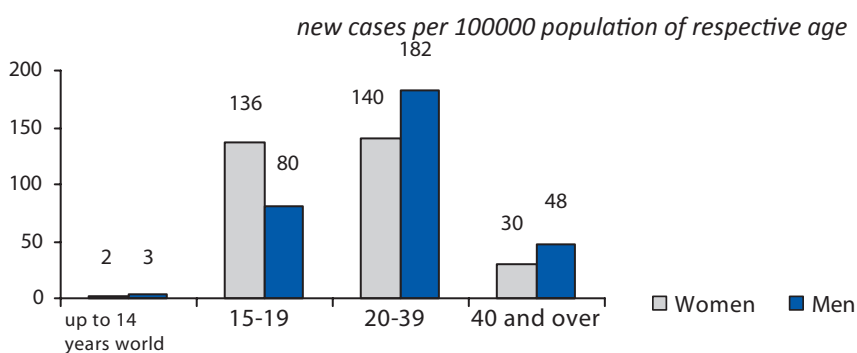

4.17. Gonorrhoea morbidity by age group, 2007

new cases per 100000 population of respective age

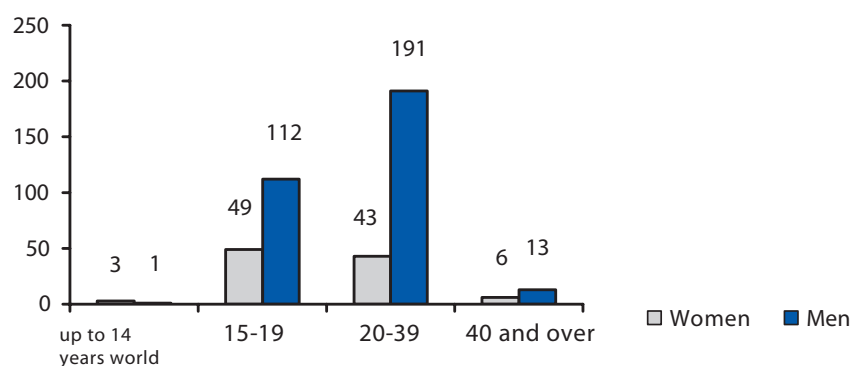

We saw above that morbidity caused by sexually transmitted infections mostly affect the age groups of 20-39 years old. At the same time, the data show that in case of women gonorrhoea and syphilis morbidity mostly affect younger age groups as compared to men. Thus, the incidence of syphilis morbidity in case of women from the age group 15 – 19 years old (136 new cases per 100 thousand inhabitants) is almost equal to that in the age groups 20-39 years old (140), while in case of men the incidence in the age group 20-39 years old is more than twice higher (182 to 80).

The same findings are with regard to morbidity by gonorrhoea, where the incidence for women from the age group 15-19 (49 new cases per 100 thousand inhabitants) is even higher than in the next age group (43), and again a prevalence of the incidence in men from the age group 20 – 39 years old.

CARRIERS OF THE HUMAN IMMUNODEFICIENCY VIRUS

4.18. Carriers of human immunodeficiency virus (HIV) by sex and age group

	2006			2007		
	T	W	M	T	W	M
Total new cases	361	160	201	418	179	239
including by age groups, years						
up to 14 years	12	6	6	7	5	2
15-19	18	16	2	21	17	4
20-39	284	118	166	304	114	190
40 and over	47	20	27	86	43	43

In 2007 there were registered for the first time 418 HIV carriers, among them men representing the highest share (239 or 57%).

The age group where the most of the cases were registered is again that of 20 – 39 years old, for both groups, however the data show that the incidence of HIV infection among women, compared to men, is higher among younger age groups. Thus, in case of women there were registered 5 carriers under 14 years old, and in case of men only 2, the same in the age group 15–19 years old and – 17 women carriers and only 4 men.

4.19. Carriers of human immunodeficiency virus (HIV) who developed AIDS disease, by sex and age group

	2006			2007		
	T	W	M	T	W	M
Total new cases	85	36	49	189	70	119
including by age groups, years						
up to 14 years old	2	1	1	6	2	4
15-19	0	0	0	0	0	0
20-39	63	20	43	137	55	82
40 and over	20	15	5	46	13	33

The incidence of cases of virus evolution into AIDS disease is also higher in men. During the same year there were registered 119 such cases among men, that represents 50% from the number of registered cases of HIV carriers, while in case of women – only 179 cases or 39% from the number of virus carriers.

4.20. Carriers of human immunodeficiency virus (HIV)

new cases per 100000 inhabitants

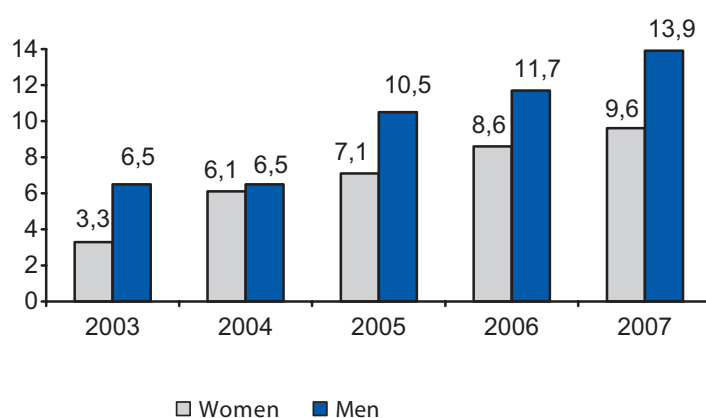

The evolution of the number of HIV carriers was a threatening one during the last years. At the same time, although the incidence of new carriers registration is higher among men, in case of women the increase is faster. Thus, in case of men the number of carriers has doubled in 2007 compared to 2003 (from 6,5 up to 13,9 new cases per 100 thousand inhabitants), while among women it increased by three times (from 3,3 in 2003 to 9,6 in 2007).

HEALTH STATUS OF WOMEN IN PRENATAL PERIOD

4.21. Health status of pregnant women, parturients and women after childbirth

	2006	2007
Number of pregnant women – total	35815	37090
of them:		
who delivered in time	33118	34174
who delivered untimely	968	1010
who interrupted the pregnancy by abortion ¹	1729	1906
Percentage of pregnant women who suffered of:		
anaemia	46,2	43,7
circulatory system diseases	1,9	1,7
diabetes Mellitus	0,1	0,1
late gestosis	2,4	2,6
diseases of the genitourinary system	11,2	11,0
venous complications of pregnancy	2,1	2,2

	2006	2007
Diseases that caused delivery complications (per 1000 births):		
anaemia	268,1	245,8
circulatory system diseases	13,4	18,3
diabetes Mellitus	1,0	1,0
late gestosis	35,1	47,0
diseases of the genitourinary system	63,0	70,1
venous complications in the period after childbirth	3,4	3,7
intrapartum and postpartum haemorrhage	17,1	18,8
labour abnormalities	114,1	103,3

¹ Spontaneous and according to medical indications

In 2007 there were registered 37090 pregnant women, by 1275 cases more compared to 2006. At the same time, the percentage of births delivered in time from the total of pregnant women in 2007 was of 92,1%, by 0,4% less than in 2006. This decrease is due to the increase in the share of pregnancy interruptions, because in 2007 there were performed 1906 interruptions, representing 5,1% from the total of pregnant women, while in 2006 this share was of 4,8%. The number of premature births increased also, representing 1010 cases in 2007, however remained constant as percentage from the total number of pregnant women (2,7%).

Anaemia is the main challenge for the health of pregnant women. 43,7% of the total of pregnant women suffered of this disease, causing complications to 245,8 births from 1000. A significant number of women (11%) suffered of genitourinary system diseases, which caused complications in 70,1 cases from 1000. It is good that the incidence of these two diseases, which also are the most common, decreased as compared to 2006 by several percents (2,5% and, respectively, 0,2%).

As for diseases that caused complications to birth, after anaemia, that causes complications the most often, follows not the diseases of the genitourinary system, but labour abnormalities, giving complications to 103,3 deliveries from 1000.

4.22. Number of pregnant women and deliveries in time, 2003-2007

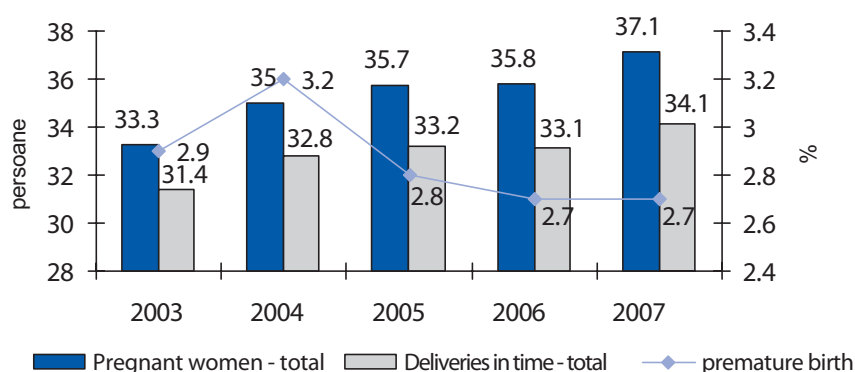

The last several years were noticed by the increase in the number of births in general and especially of the deliveries in time, on the decrease ceiling, after a peak period in 2004 of premature births. If as a number of pregnancies and deliveries in time the evolutions were firmly increasing in the period 2003-2007, the evolution of the share of premature births in 2004 registered a sharp and significant decrease in the total number of births (from 2,9% in 2003 to 3,2% in 2004), then a decrease again a very sharp one (2,8% in 2005) and stabilization at 2,7% in 2006 and 2007.

4.23. Doctors by category and sex

thousand persons

	2006			2007		
	T	F	B	T	F	B
Total	12,7	7,0	5,7	12,7	7,3	5,4
including: superior category	4,6	2,3	2,3	4,8	2,4	2,4
I	2,8	1,6	1,2	2,8	1,6	1,2
II	1,4	0,8	0,6	1,5	0,8	0,7

As it could be seen also from the statistical data on labour force employment women prevail in the field of health protection from a quantitative point of view. In 2007 in hospitals there were working about 12,7 thousand doctors, of them 7,3 thousand women (57%). Compared to 2006, the number of doctors remained constant, however gender distribution suffered changes in the direction of women share increasing.

If analyzing the distribution of staff by categories, we could notice professional evolutions of women and men: on average male doctors hold a higher category. Thus, 2,4% of male doctors from the total of 5,4 thousand were holding superior category, while among women – also 2,4%, but this share was from the total of 7,3 thousand, so the proportion is lower. This vertical inequality we can find also in the relative comparison of gender distribution of the entire medical staff compared to that among doctors. In 2007 the health protection field was counting 50,8 thousand women and 13,8 thousand men among the employees. Doctors' share in the total of male employees was 39%, while among female employees – less than 15%.

DISABLED PERSONS

4.24. Distribution of persons aged 16 and over, recognized as disabled for the first time by sex, age group and area of residence

thousand persons

	2006				2007			
	Urban		Rural		Urban		Rural	
	W	M	W	M	W	M	W	M
Total	2484	3008	3521	4687	2672	3212	3285	4610
out of them by age:								
up to 29	168	244	324	483	170	257	279	427
30-39	280	268	396	523	246	286	397	482
40-49	650	712	1024	1189	732	727	922	1120
50 and over	1386	1784	1777	2492	1524	1942	1687	2581

In 2007 there were recognized as disabled for the first time 13779 people, of them - 5957 women (43%) and 7822 (57%), most of them residing in rural area. The highest share of disabled persons is part of the age groups over 50 years old (more than half of them), that is valid also for all groups according to gender and area of residence.

4.25. Number of persons recognized as disabled for the first time by sex

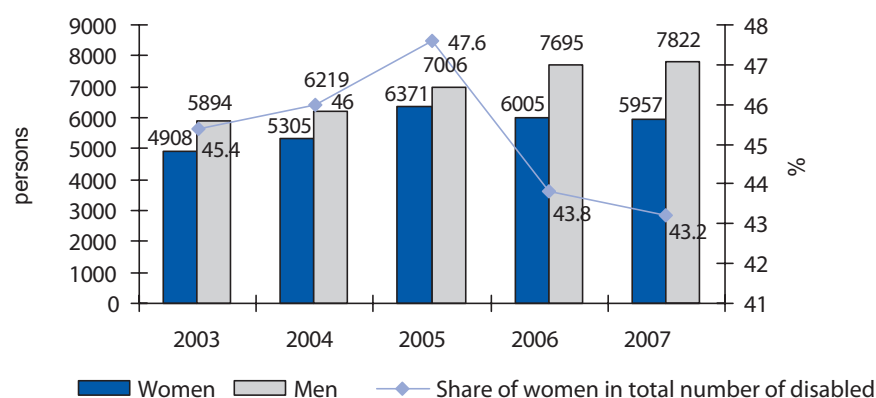

The overall number of people recognized as disabled for the first time increased constantly during years, however the trend among women was an increasing one until 2005, then – decreasing, fact that determined also the evolution of women’s share in total number of disabled from 45,4 in 2003 to 47,6% (maximal) in 2005 and then reduction to 43,2% in 2007, this being the lowest share registered during those five years we have presented data.

4.26. Share of persons recognized as disabled for the first time per 1000 persons of respective age group, in 2007

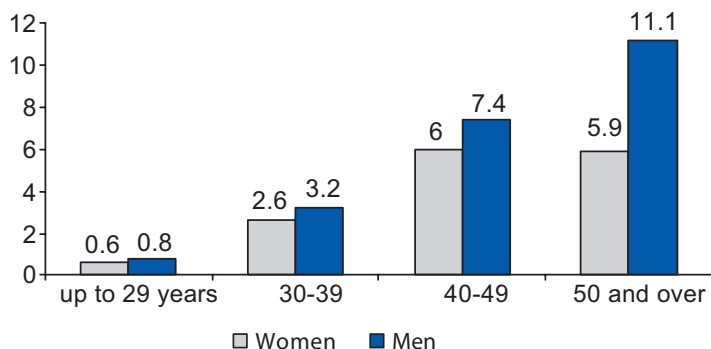

The group of disabled women differ not only numerically by that of men, but also as age structure. In case of men the maximum incidence of disability occurs within the age group of over 50 years (11,1 cases per 1000 persons of the respective group), being almost double as compared to the indicator in the 40-49 age group. In case of women such discrepancies are absent, the incidence being almost equal in the age groups 40–49 and over 50 years old (6 and 5,9 disabled per 1000 persons), that means that women become invalids at a younger age as compared to men.

HEALTH STATUS ESTIMATION

4.27. Health status estimation by sex, 2007⁹

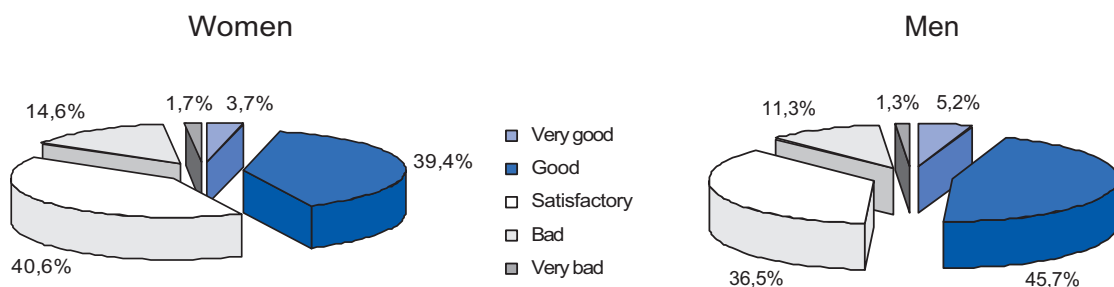

Contrary to statistical data with regard to health (we saw above that the incidence of tuberculosis, sexually transmitted infections, HIV/AIDS, disability rate among men is higher than in women), men appreciate their health status a little bit better than women. 50,9% of men appreciate their health status as being good and very good and only 43,1% of women do so.

Overestimation of own health status is characteristic to all age groups, and both men and women appreciate their health status as worse as they get older.

⁹ Based on Household Budgets Survey data

4.28. Health status estimation by sex and age group, 2007¹

	16-24		25-44		45-57		58 and over	
	W	M	W	M	W	M	W	M
Total	100,0	100,0	100,0	100,0	100,0	100,0	100,0	100,0
including health status being:								
Very good	6,4	8,4	3,3	4,8	0,8	1,7	-	0,6
Good	65,3	67,3	46,2	50,8	20,6	24,8	4,6	8,4
Satisfactory	24,8	20,3	43,1	37,7	57,9	57,2	53,2	54,4
Bad	3,3	3,7	7,1	5,9	19,3	15,0	36,6	32,3
Very bad	0,3	0,3	0,3	0,7	1,4	1,4	5,6	4,3

SMOKERS

4.29. Share of people smoking daily or occasionally by age group and sex¹⁰, 2005

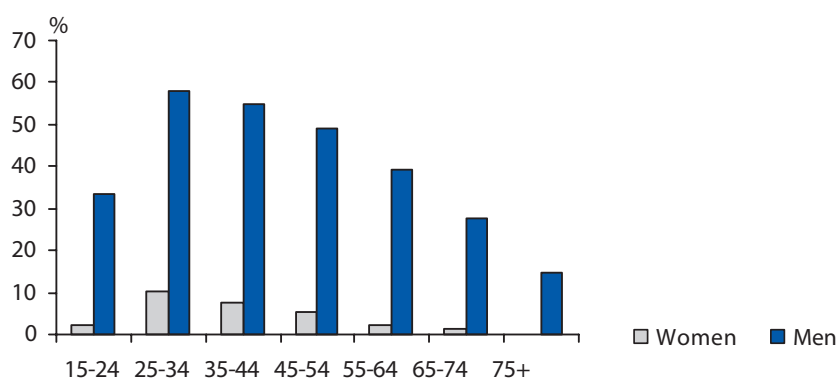

4.30. Share of people who never smoked by age group and sex, 2005

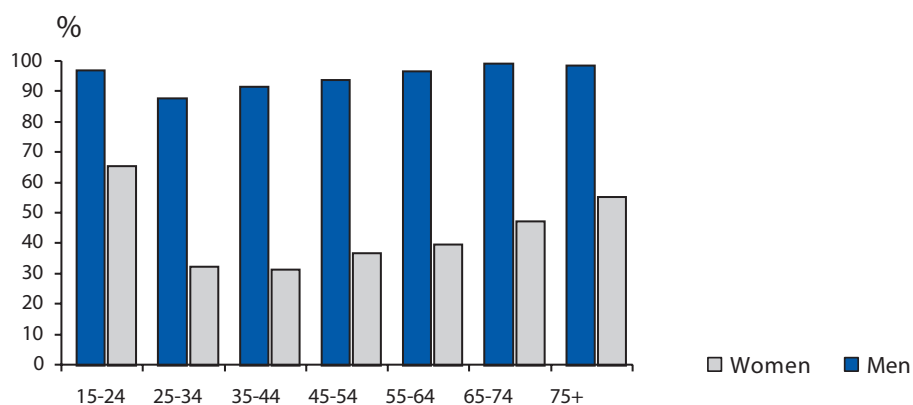

Smoking is a vice shared especially by men in the Republic of Moldova. The share of smokers among men is net higher than among women, irrespective of age.

The age groups with highest share of smokers are those in the middle, between 25 and 54 years old. At the same time, the figures regarding the share of people who never smoked show that smoking does not vary as share of smokers, but only depending on age. It seems that smoking varied during different decades, especially among men.

We could say that during the last century a permanent increase of the share of smokers occurred, because, if not taking into consideration the age group 15–24 years (among which we have the highest share of people who never smoked probably because of young age), the share of people who never smoked increases while people get older.

¹⁰ Based on Population Health Study data

Usually, men start smoking at an earlier age (57,7% about 15 – 19 years old and 26,4% about 20–24 years old), while in case of women, although the majority of them began to smoke at the same age (15–19 and 20–24 years old), the group of those who smoked for the first time after 30 years old is significant – 22,9%.

4.31. Structure of smoking population aged 15 and over , by the age they began smoking, by sex and age groups, 2005²

	Total persons	of them, by the age they began smoking:				
		under 15 years old	15-19 years old	20-24 years old	25-29 years old	30 years old and over
TOTAL	100,0	8,0	54,7	26,7	5,1	5,5
15-24	100,0	9,8	77,1	13,1	-	-
25-34	100,0	6,9	61,0	24,9	6,6	0,7
35-44	100,0	10,2	47,0	29,4	4,3	9,1
45-54	100,0	7,0	52,9	28,5	3,2	8,4
55-64	100,0	7,5	41,3	35,2	9,7	6,2
65-74	100,0	6,8	53,8	25,5	8,9	5,0
75 +	100,0	8,4	45,6	28,6	2,1	15,3
MEN	100,0	8,8	57,7	26,4	3,9	3,2
15-24	100,0	8,6	79,8	11,6	-	-
25-34	100,0	8,3	64,2	23,5	4,0	-
35-44	100,0	11,8	50,6	29,4	2,6	5,6
45-54	100,0	7,8	57,5	27,9	2,0	4,8
55-64	100,0	8,2	42,4	35,7	9,2	4,6
65-74	100,0	7,0	55,7	26,4	8,1	2,7
75 +	100,0	9,4	50,6	31,8	2,3	5,9
WOMEN	100,0	2,2	31,6	29,1	14,2	22,9
15-24	100,0	21,0	52,3	26,6	-	-
25-34	100,0	-	46,0	31,7	18,5	3,9
35-44	100,0	-	24,4	29,6	14,8	31,3
45-54	100,0	-	13,7	33,5	13,0	39,8
55-64	100,0	-	29,5	29,8	15,8	24,9
65-74	100,0	-	-	-	31,8	68,2
75 +	100,0	-	-	-	-	100,0

OBESITY

4.32. Share of obese people by age group and sex, 2005¹

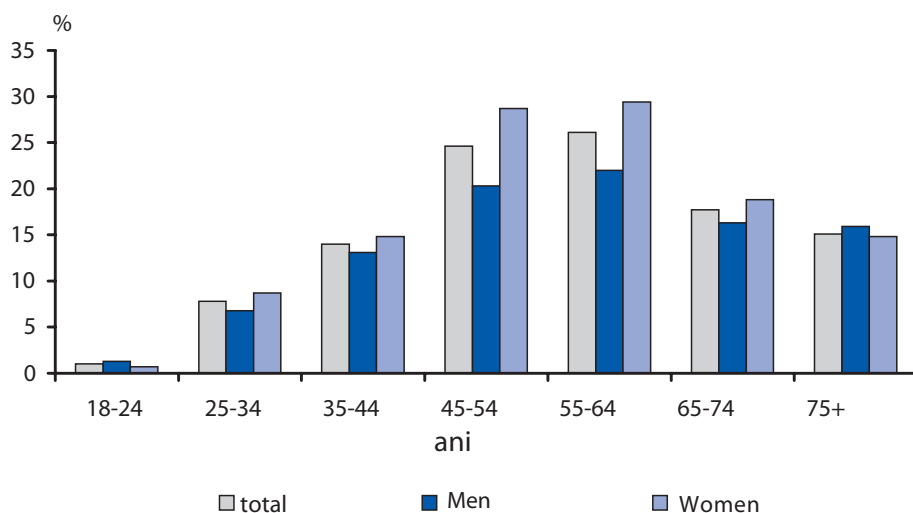

Among women incidence of obesity is a little higher than among men, that is also valid for all age groups, except people over 75 years old. The highest share of obese people of both sexes is registered in age groups of 45–54 years old (29% women and 20% men) and 55–64 years old (29% women and 22% men).

4.33. Structure of population aged 18 and over according to Body Mass Index, by sex and age group, 2005²

	Total persons	Of them, according to Body Mass Index (%):						Average Body Mass Index kg/m ²
		under 18.0 kg/m ²	18.0-19.9 kg/m ²	20.0-24.9 kg/m ²	25.0-26.9 kg/m ²	27.0-29.9 kg/m ²	30.0 kg/m ² and over	
TOTAL	100,0	1,3	5,8	42,9	17,4	17,2	15,4	25,6
18-24	100,0	4,6	17,1	65,6	8,0	3,6	1,0	21,9
25-34	100,0	2,0	10,2	53,0	15,2	11,8	7,8	24,1
35-44	100,0	0,5	2,7	44,7	18,7	19,4	14,0	25,7
45-54	100,0	0,7	1,8	31,0	20,3	21,6	24,6	27,4
55-64	100,0	-	1,8	29,0	18,6	24,4	26,1	27,5
65-74	100,0	0,2	2,7	35,7	23,1	20,5	17,7	26,6
75 +	100,0	1,3	3,7	41,9	17,8	20,2	15,1	25,8
MEN	100,0	0,7	3,2	45,9	18,8	18,1	13,3	25,6
18-24	100,0	3,1	9,2	70,1	11,4	4,9	1,3	22,6
25-34	100,0	0,3	4,0	56,6	18,3	13,9	6,8	24,6
35-44	100,0	-	0,8	43,3	20,1	22,7	13,1	26,1
45-54	100,0	0,6	1,9	36,1	20,1	21,1	20,3	26,6
55-64	100,0	-	1,0	31,9	18,7	26,4	22,0	27,1
65-74	100,0	-	2,6	39,2	22,2	19,8	16,3	26,2
75 +	100,0	-	4,2	35,0	26,2	18,7	15,9	26,2
WOMEN	100,0	1,8	7,9	40,4	16,2	16,5	17,1	25,6
18-24	100,0	6,2	24,9	61,2	4,7	2,4	0,7	21,2
25-34	100,0	3,5	15,9	49,7	12,3	10,0	8,7	23,6
35-44	100,0	0,8	4,4	45,8	17,5	16,7	14,8	25,4
45-54	100,0	0,7	1,8	26,1	20,5	22,1	28,7	28,0
55-64	100,0	-	2,5	26,7	18,5	22,9	29,4	27,7
65-74	100,0	0,4	2,9	33,1	23,8	21,1	18,8	26,8
75 +	100,0	1,8	3,4	44,8	14,3	20,9	14,8	25,7

The normal value (normoponderal) of Body Mass Index is between 18,5 and 24,9 points. In 2005, every second adult citizen had an index over normal (higher than 24,9), and 15,4% had an index over 30, thus they are obese persons.

Although the average body mass index is 25,6 both for men and women, the share of obese women (with a body mass index over 30) is higher than that of men by 5 percent points (17,1% compared to 13,3%).

By age group, both for women and men, only the age groups of 18–34 years old have an average body mass index within the limits of the normal. Prevalence of obesity among women compared to men is ensured due to the age groups between 45 and 74 years old; for these generations the average body mass index of women is higher than that of men.

ALCOHOL CONSUMPTION, 2005

4.34. Structure of male population by the frequency of alcohol consumption, %

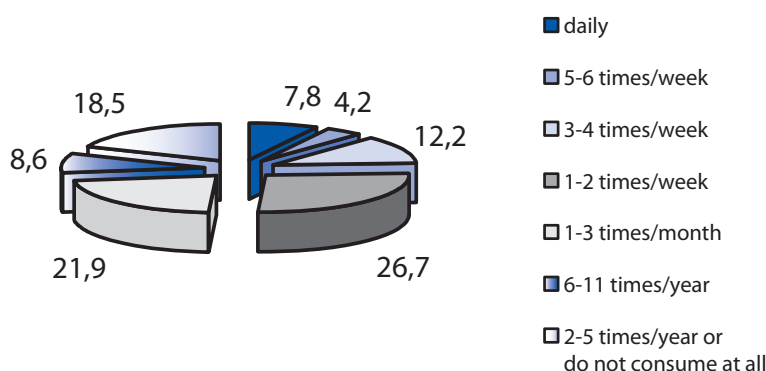

4.35. Structure of female population by the frequency of alcohol consumption, %

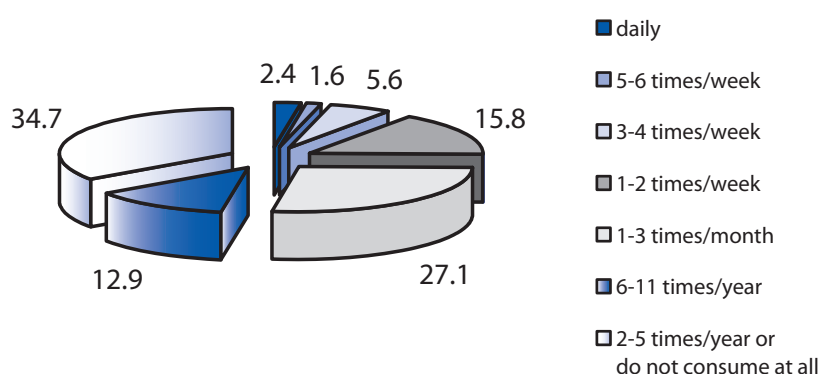

Alcohol consumption among men has higher parameters than compared to women. Every second man consumes alcohol 1–2 times per week or more, while, among women, this percentage represents 25%. About 35% of women and only 18,5% men use alcohol 2-5 times per year or do not use alcohol.

4.36. Structure of population aged 15 and over by the frequency of alcohol consumption during the last 12 months, by sex and age groups, %

	Total persons	of them, by frequency of alcohol consumption						
		Daily	5-6 times/ week	3-4 times/ week	1-2 times/ week	1-3 times/ month	6-11 times/year	2-5 times/ year and do not use alcohol
TOTAL	100,0	4,9	2,8	8,6	20,8	24,7	10,9	27,3
15-24	100,0	0,1	0,8	3,9	13,8	28,3	11,8	41,2
25-34	100,0	2,7	2,6	7,0	28,5	30,2	10,9	18,1
35-44	100,0	5,5	4,1	11,7	24,9	26,7	10,7	16,5
45-54	100,0	5,1	3,5	11,8	24,4	26,1	10,6	18,6
55-64	100,0	6,5	2,9	9,6	20,9	20,9	10,6	28,6
65-74	100,0	12,3	2,3	7,6	14,2	18,0	11,3	34,2
75 +	100,0	5,6	3,8	9,6	13,0	12,4	10,5	45,2
MEN	100,0	7,8	4,2	12,2	26,7	21,9	8,6	18,5
15-24	100,0	0,3	1,7	5,2	19,3	27,5	11,0	35,0
25-34	100,0	4,6	4,0	9,6	36,1	23,9	8,0	13,8
35-44	100,0	9,5	7,0	18,4	29,1	20,2	5,3	10,5

	Total persons	of them, by frequency of alcohol consumption						
		Daily	5-6 times/ week	3-4 times/ week	1-2 times/ week	1-3 times/ month	6-11 times/year	2-5 times/ year and do not use alcohol
45-54	100,0	7,7	4,6	18,4	31,1	21,6	6,6	10,0
55-64	100,0	9,9	3,3	13,8	28,4	15,9	9,7	19,0
65-74	100,0	20,8	3,4	7,2	18,2	21,6	13,1	15,6
75 y+	100,0	11,6	9,3	13,5	11,4	15,6	6,3	32,2
WOMEN	100,0	2,4	1,6	5,6	15,8	27,1	12,9	34,7
15-24	100,0	-	-	2,7	8,5	29,1	12,5	47,2
25-34	100,0	0,9	1,4	4,5	21,6	35,8	13,5	22,2
35-44	100,0	2,1	1,7	6,0	21,3	32,2	15,2	21,4
45-54	100,0	2,5	2,5	5,5	18,0	30,4	14,3	26,7
55-64	100,0	3,9	2,6	6,3	15,0	24,9	11,2	36,1
65-74	100,0	5,9	1,5	7,9	11,1	15,3	9,9	48,4
75 +	100,0	3,0	1,5	8,0	13,7	11,0	12,2	50,6

The highest share of alcohol consumers are registered in the generations of 25–44 years old, which is valid for both groups. The most intense consumption is registered in the age group of 65–74 years old, where 20,8% men and 5,9% women use alcohol daily, these being the maximum shares of persons with daily alcohol consumption among all age groups.

5. INTERNATIONAL MIGRATION

5.1. Number of emigrants and immigrants

persons

	2006		2007	
	W	M	W	M
Emigrants	3674	3011	3896	3276
Immigrants	1188	2465	1501	2332

Both in 2006 and 2007 more people have emigrated from the Republic of Moldova compared to the number of people that immigrated. Gender differences are significant in sense that more women than men chose to emigrate, while in the Republic of Moldova came more men immigrants than women.

5.2. Emigrants by destination country

persons

Country	2006		2007	
	W	M	W	M
Total	3674	3011	3896	3276
of them, left for:				
Austria	36	6	10	3
Belarus	112	110	102	85
Canada	10	8	7	5
Czech Republic	15	12	9	15
Germany	167	86	171	82
Israel	110	91	71	69
Kazakhstan	12	10	12	8
Romania	6	2	2	2
Russia	1503	1387	1635	1475
USA	315	297	356	339
Ukraine	1365	985	1482	1181
Other countries	23	17	39	12

5.3. Emigrants by age group

people

Age group, years	2006		2007	
	W	M	W	M
Total	3674	3011	3896	3276
under 20	209	190	226	222
20-29	1066	958	1127	1058
30-39	715	746	868	805
40-49	474	418	486	488
50-59	557	358	660	373
60-69	364	206	296	217
70+	289	135	233	113

The favourite destination country for emigrants was Russia, closely followed by Ukraine, without any significant gender differences in this sense. The third preferred destination country is (situated on a place far away from the first two) was the USA.

The majority of emigrants, both women and men, are part of the age groups 20-29 years old and 30-39 years old, the working age groups, we could draw the conclusion that they left to work in the destination countries. Also, the majority of emigrants, regardless of sex, have secondary/high-school education. Emigrants with higher education represent less than 15% of the total.

5.4. Emigrants by age group, in 2007

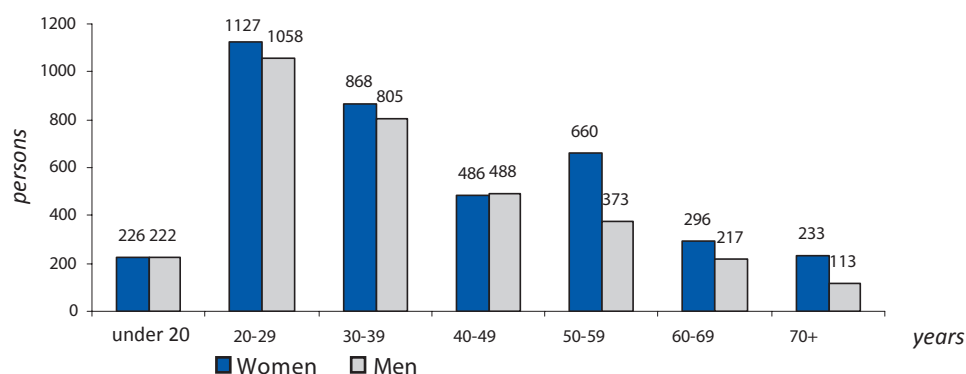

5.5. Emigrants by level of education

	2006		2007	
	W	M	W	M
Total	3674	3011	3896	3276
<i>By level of education:</i>				
higher education	490	311	456	297
incomplete higher education	194	109	189	153
secondary specialized (colleges)	689	568	781	557
General secondary school, high-school	1472	1294	1558	1406
Gymnasium education	739	691	824	821
Others	86	36	75	41
<i>by scientific degree</i>				
Doctor of Science	3	1	-	-
Ph.D.	1	1	3	1

5.6. Characteristics of immigrants by the purpose of their arrival in the country of emigration

Country	2006			2007		
	study	work	family im-migration	study	work	family
Total arrived*	445	828	695	221	1002	847
including:						
Armenia	1	11	23	-	4	23
Azerbaijan	2	29	34	1	59	33
Bulgaria	64	9	2	29	15	4
Belarus	4	6	21	5	2	20
Germany	4	13	1	1	14	4
France	-	19	1	-	18	2
Israel	48	14	10	42	8	6
Italy	2	37	11	-	74	10
Romania	5	121	45	9	128	60
Russia	33	9	140	26	53	177
Syria	15	11	17	2	8	21
USA	3	90	19	-	65	25
Turkey	135	251	57	43	337	82
Ukraine	84	64	206	6	72	288
Uzbekistan	14	1	6	12	5	7
Other countries	31	143	102	45	140	85

* without repatriated people

5.7. Immigrants by nationality

persons

Nationality:	2006	2007
Total	3576	3833
of them:		
Arabian	129	91
Armenian	39	39
American	104	80
Azerbaijani	66	100
Bulgarian	115	111
Jewish	56	108
Italian	50	84
Moldovan	979	928
Russian	501	648
Romanian	182	212
Turkish	441	466
Ukrainian	438	588
Gagauz	60	80
Other nationalities	416	298

The most immigrants that came to the Republic of Moldova for study and work are from Turkey; however, if to take into account repatriated people, then the most of them are Moldovans. Depending on the nationality, the number of Russian immigrants follows immediately the Moldovans, closely followed by Ukrainians.

5.8. Structure of refugees by sex and age group at the end of 2007

Age group, years	People		In % to the total	
	W	M	W	M
Total	45	106	29,8	70,2
0-17	17	14	54,8	45,2
18-59	25	90	21,7	78,3
60 and over	3	2	60,0	40,0

With regard to refugees, in 2007 there were 151 refugees in the Republic of Moldova, more than 70% being men. There are significant gender differences at the level of age group of 18-59 years old, where the majority of refugees are men, as well as at the level of the country of origin, 29% of female refugees being from Russia and also 29% from Armenia, compared to only 11% men from Russia and also 11% from Armenia.

5.9. Distribution of refugees by country of origin, at the end of 2007

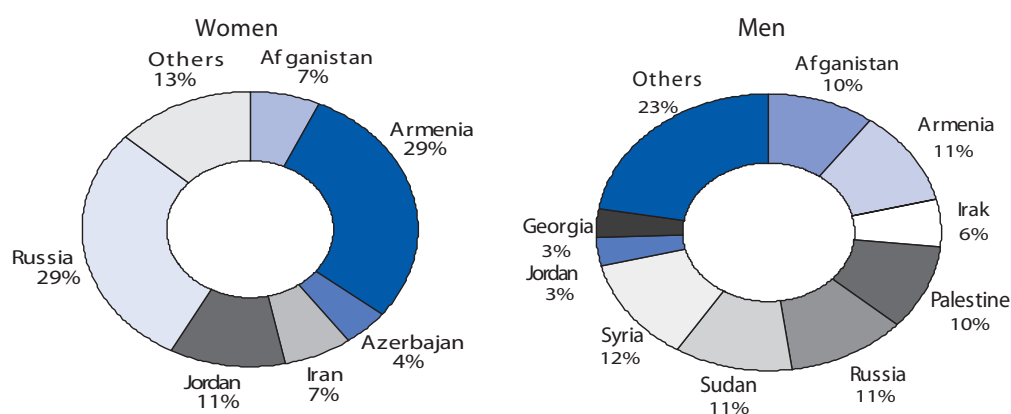

5.10. Distribution of asylum seekers by sex and age group, at the end of 2007

Age group, years	Persons		In % to the total	
	W	M	W	M
Total	13	66	16,5	83,5
0-17	2	5	28,6	71,4
18-59	10	61	14,1	85,9
60 and over	1	-	100	-

In 2007, about 79 people were seeking asylum in the Republic of Moldova, over 83% of them being men from 0-17 and 18-59 age groups. Gender specifics in this case is that at the level of the age group of 60 years old and over the asylum seekers were exclusively women.

6. LABOUR MARKET

LABOUR FORCE

6.1. Distribution of population aged 15 and over, by its participation in the economic activity

thousand persons

	2006				2007			
	Urban		Rural		Urban		Rural	
	W	M	W	M	W	M	W	M
Economically active population	293,3	324,4	373,6	365,8	293,5	295,9	357,3	367,2
Employed population	271,8	289,1	356,9	339,4	277,7	271,0	348,0	350,6
Unemployed	21,5	35,3	16,7	26,3	15,8	24,9	9,3	16,6
Economically inactive population	358,2	266,3	526,6	424,9	381,1	281,9	512,0	442,9

Source: NBS, Labour Force Survey.

Distribution of population aged 15 and over, by its participation in the economic activity



6.2. Distribution rate of population aged 15 and over, by its participation in the economic activity

percent

	2006				2007			
	Urban		Rural		Urban		Rural	
	W	M	W	M	W	M	W	M
Activity rate	45,0	54,9	41,5	46,3	43,5	51,2	41,1	45,3
Employment rate	41,7	48,9	39,6	42,9	41,2	46,9	40,0	43,3
Unemployment rate	7,3	10,9	4,5	7,2	5,4	8,4	2,6	4,5
Inactivity rate	55,0	45,1	58,5	53,7	56,5	48,8	58,9	54,7

Source: NBS, Labour Force Survey.

In 2006 women were representing almost half from the total of the economically active population (49,14%) and remains the same in 2007 (49,53%). With regard to the differences between area of residence, there are no major differences at the level of the last 2 years: in 2006 about 45% of the total economically active urban population were women and 41,5% of the total economically active rural population were women, while in 2007 both in urban and rural areas, the share of women from the total of economically active population decreases to 43,5% and respectively to 41,1%.

Distribution rate of population aged 15 and over, by its participation in the economic activity



With regard to the employment rate, if comparing the existent data for 2006 to those for 2007 from a gender perspective, we notice that in urban area in 2007 women participation rate maintained about 41% (with a decrease of 0,5 percentage points), while in rural area, this rate increased in 2007 by 0.4 percentage points (from 39,6% to 41%). The same tendency is observed also in case of men both in urban and rural areas (a slight decrease in urban area and a slight increase in rural area).

At the level of both years analyzed, the unemployment rate in women is lower than the unemployment rate in men (in 2006 it was by 3,6% lower in urban area and by 2,7% in rural area, and in 2007 it was by 3% lower than in urban area and by 1,9% in rural area). In 2007 it is noticed a general tendency of decrease of the unemployment rate, irrespective of sex and area of residence.

Nevertheless, the share of inactive population at the level of the Republic of Moldova remains high, registering only a slight fluctuation during the whole period 2003-2007. During this period, both female inactivity and male inactivity didn't decrease under 40%, however it increased many times more than 50%, and always the inactivity rate was higher in women than in men. Also the situation for the last two years remains the same: women inactivity rate in urban area in 2007 increased by 1,5 percentage points as compared to 2006, and in rural area - by 0,4%. In case of men, the inactivity rate increased in 2007 as compared to 2006 both in urban and rural areas.

If analyzing the economically active population from age group perspective, it is noticed that there are more economically active women than men in the age groups between 15-39 years old both in urban area and rural area (except rural area for the age group 30-39). Between 40-54 age group the situation reverses, more women than men being economically active. For the age groups of over 55 years old it goes back to the initial situation. There are no major differences at the level of the last 2 years, although, generally, the number of economically active women slightly increased in 2007 as compared to 2006, while the number of men slightly decreased.

6.3. Economically active population by age group

thousand persons

	2006				2007			
	Urban		Rural		Urban		Rural	
	W	M	W	M	W	M	W	M
Economically active population, total	293,3	324,4	373,6	365,8	293,5	295,9	357,3	367,2
15-19 years old	4,4	7,9	16,0	21,6	2,7	6,9	9,2	15,7
20-24 years old	21,1	30,8	26,8	31,1	24,0	31,6	23,3	27,0
25-29 years old	31,4	44,8	25,7	30,2	34,3	37,8	24,9	29,0
30-34 years old	33,6	41,2	37,1	31,9	33,5	36,1	33,4	34,0
35-39 years old	29,0	31,9	42,3	40,0	34,1	32,3	42,8	39,1
40-44 years old	41,8	38,9	53,3	46,5	43,2	35,5	51,4	45,8
45-49 years old	59,4	48,4	65,9	57,8	52,7	42,3	64,1	58,6
50-54 years old	40,8	36,2	42,9	42,0	35,5	31,7	44,0	43,5
55-59 years old	24,5	29,6	31,6	33,3	25,2	28,8	33,5	40,0
60-64 years old	3,8	9,6	12,6	14,3	4,9	8,6	13,1	14,2
65 +	3,5	5,3	19,5	17,2	3,5	4,2	17,6	20,2

Source: NBS, Labour Force Survey.

6.4. Population of 20-49 years old by its participation in the economic activity, number of pre-school aged children, by sex and area of residence, in 2007

	Total		Urban		Rural	
	W	M	W	M	W	M
Persons who do not have pre-school aged children						
Active persons	373,7	331,7	183,6	161,5	190,1	170,2
of them:						
Employed	356,9	307,5	172,4	146,7	184,5	160,8
Unemployed	16,9	24,2	11,2	14,8	5,6	9,4
Activity rate, %	59,4	52,7	62,1	59,2	57,0	47,8
Employment rate, %	56,8	48,9	58,3	53,8	55,4	45,1
Unemployment rate ILO, %	4,5	7,3	6,1	9,2	3,0	5,5
Persons who have at least one child of pre-school age						
Active persons	87,8	117,5	38,0	54,2	49,8	63,3
of them:						
Employed	84,2	111,4	36,0	50,9	48,2	60,5
Unemployed	3,6	6,1	2,0	3,3	1,6	2,8
Activity rate, %	43,1	63,1	42,8	70,1	43,4	58,0
Employment rate, %	41,4	59,8	40,5	65,9	42,1	55,4
Unemployment rate ILO, %	4,1	5,2	5,3	6,1	3,2	4,5

It is noticed that the activity rate, as well as the employment rate is decreasing in case of women that have at least one pre-school aged child compared to men in the same situation. This shows that more women than men interrupt their activity or leave the labour market to take care of their pre-school aged children.

EMPLOYMENT

6.5. Employed population by age group

thousand persons

	2006				2007			
	Urban		Rural		Urban		Rural	
	W	M	W	M	W	M	W	M
Employed population, total	271,8	289,1	356,9	339,4	277,7	271,0	348,0	350,6
15-24 years	20,8	30,7	36,6	44,3	22,3	32,1	28,8	37,0
25-34 years	60,1	77,1	59,5	55,5	64,0	68,5	56,2	58,9
35-44 years	65,3	63,1	92,3	80,5	73,8	62,9	92,4	81,4
45-54 years	94,9	76,9	105,4	95,3	84,7	69,0	106,7	99,5
55-64 years	27,3	36,0	43,7	46,7	29,4	34,4	46,4	53,5
65 +	3,4	5,3	19,5	17,1	3,5	4,2	17,6	20,2

Source: NBS, Labour Force Survey.

Employed population by age group

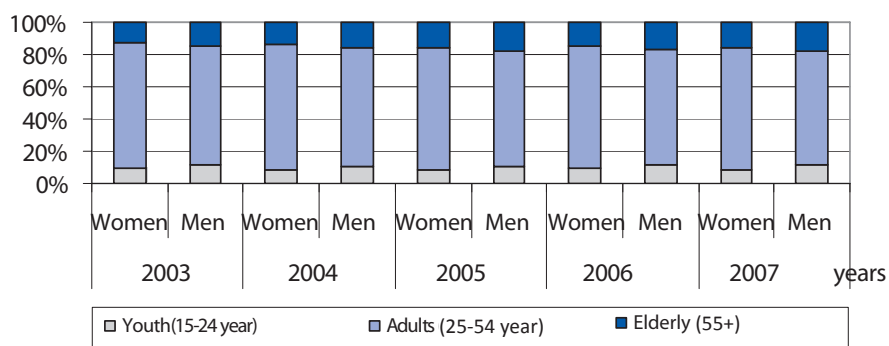

6.6. Employment rate by age group

thousand persons

	2006				2007			
	Urban		Rural		Urban		Rural	
	W	M	W	M	W	M	W	M
employed population, total	41,7	48,9	39,6	42,9	41,2	46,9	40,0	43,3
15–24 years	15,8	22,4	17,2	20,4	14,1	21,3	16,4	19,2
25–34 years	51,7	63,1	47,7	44,1	55,7	62,3	45,3	44,3
35–44 years	59,9	64,3	63,2	57,9	64,2	64,8	63,7	55,8
45–54 years	67,5	63,0	63,0	64,2	66,7	62,7	65,1	63,4
55–64 years	36,2	57,5	42,5	61,9	37,2	58,3	44,2	63,7
65 +	4,3	10,9	13,3	20,2	4,3	8,2	11,3	20,8

Source: NBS, Labour Force Survey.

During 2003–2007, the majority of the employed population, regardless of sex or area of residence, were adults aged between 25–54 years, followed by elderly persons (55 years and above) and young people (15–24 years).

At the same time, the employment rate of the adults decreased, while that of the young and elderly remained at the same level, the recorded fluctuations are not significant. The most drastic decrease was noticed at adult women's employment rate - almost 10% less from 2003 to 2007. The young people's employment rate (15–24 years) continued to be the smallest, in 2007 it decreased more obviously.

The most important gender gaps in the employment rate are noticed for the whole period with regard to the elderly population, where the women's employment rate is nearly up to 20% lower than that of the men.

Graph 3 groups: young people, adults, elderly persons

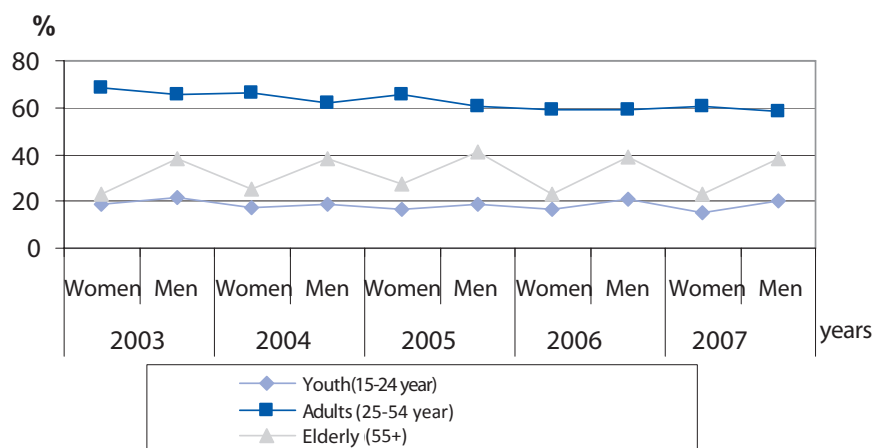

6.7. Employed population by education level

Thousand persons

	2006				2007			
	Urban		Rural		Urban		Rural	
	W	M	W	M	W	M	W	M
Employed population, total	271,8	289,1	356,9	339,4	277,7	271,0	348,0	350,6
Higher	99,4	99,4	37,0	24,7	99,7	87,8	35,8	24,0
Specialized secondary education	63,3	45,4	66,5	39,1	71,1	39,9	62,3	38,0
Vocational secondary education	50,0	78,2	58,8	107,2	48,2	77,8	63,4	119,2
Lyceum; general secondary	43,6	48,4	88,9	69,8	43,6	48,8	89,2	72,0
Gymnasium	15,0	17,2	90,0	86,7	14,7	16,0	87,3	87,3
Primary or no school	0,6	0,5	15,8	12,0	0,3	0,7	10,0	10,0

Source: NBS, Labour Force Survey.

According to the education level, during the whole period 2003-2007, regardless of the sex, the majority of the employed population has a medium level of education, the percentage of the employed persons having a lower level of education is lower, compared to persons having higher level of education.

With regard to the employment rates depending on the level of education, they raise together with the education level. There are still gender discrepancies depending on the area of residence. Thus, the employment rate of women with higher, specialized secondary and vocational secondary education is lower than that of men, with the same level of education in the urban area, but is higher in rural areas.

Both in the rural and in the urban area, the employment rate of women with lyceums, gymnasiums and primary education/ no school is lower than that of the men with the same level of education (exception for the women with lyceum education from rural areas, in this case the employment rate in 2007 is 0,3% higher than that of the men).

Employed population by education level

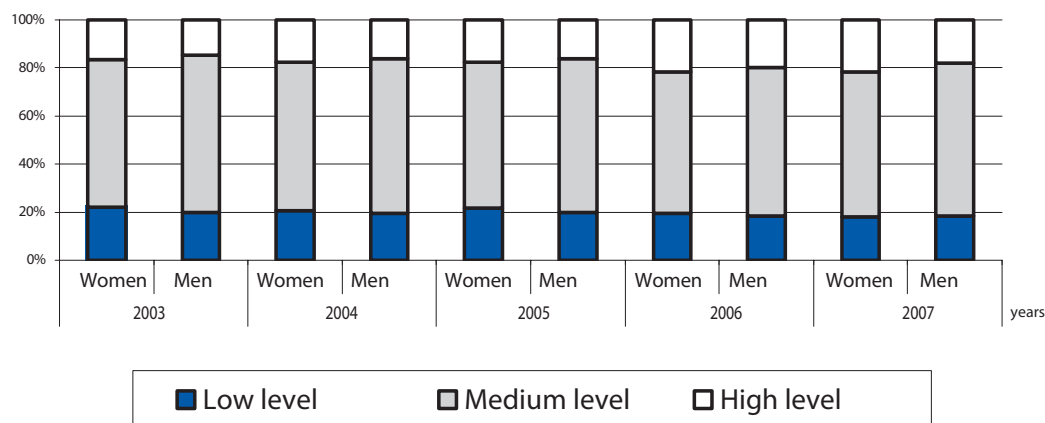

6.8. Employment rate by level of education

percent

	2006				2007			
	Urban		Rural		Urban		Rural	
	W	M	W	M	W	M	W	M
Employed population, total	41,7	48,9	39,6	42,9	41,2	46,9	40,0	43,3
Higher	62,4	71,3	66,2	64,1	65,5	69,0	66,8	62,1
Specialized secondary education	52,1	52,5	59,3	58,7	55,2	54,0	60,0	58,4
Vocational secondary education	49,5	59,6	56,1	54,7	49,0	57,9	56,7	54,8
Lyceum; general secondary	29,5	36,3	40,6	40,8	27,7	36,1	41,8	41,5
Gymnasium	17,2	22,0	33,5	35,9	14,5	19,6	32,9	36,3
Primary or no school	1,7	2,2	11,3	15,5	0,7	2,7	8,2	13,3

Source: NBS, Labour Force Survey.

Employment rate by level of education

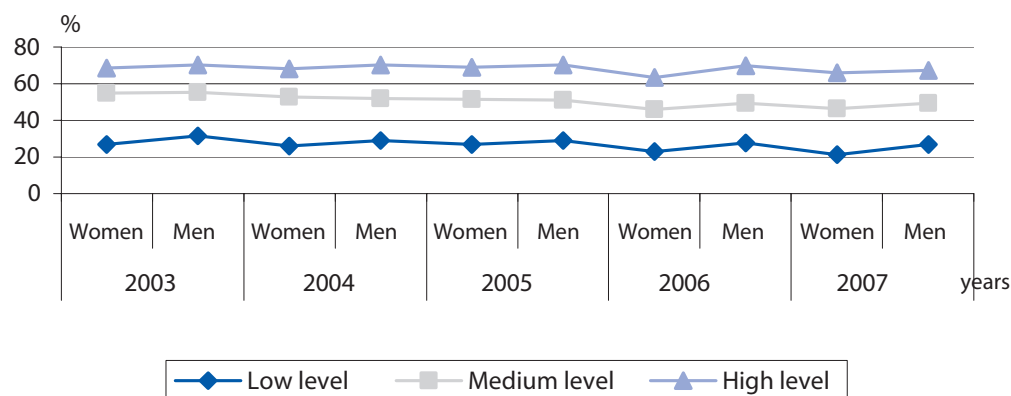

6.9. Employed population by economic activity

thousand persons

	2006				2007			
	Urban		Rural		Urban		Rural	
	W	M	W	M	W	M	W	M
Employed population, total	271,8	289,1	356,9	339,4	277,7	271,0	348,0	350,6
Agriculture, hunting, forestry and fishing	6,9	12,3	193,9	209,3	5,8	10,7	182,3	209,8
Industry	45,2	58,5	26,3	31,3	45,1	55,6	25,2	32,2
Constructions	4,7	38,5	1,8	22,4	4,8	38,4	2,3	30,2
Wholesale and retail trade; hotels and restaurants	82,5	64,2	30,3	18,9	85,2	59,3	31,8	21,5
Transports and communications	12,9	33,1	5,3	14,0	13,3	33,9	6,5	15,1
Public administration; education; health care and social assistance	84,0	48,2	89,7	34,8	86,2	39,9	89,9	34,4
Other activities	35,7	34,4	9,6	8,7	37,2	33,2	10,0	7,3
From the total:	264,9	276,9	163,0	130,1	271,8	260,3	165,7	140,8
Non-agricultural activities								

Source: NBS, Labour Force Survey.

Employed population by sex and economic activity, 2007

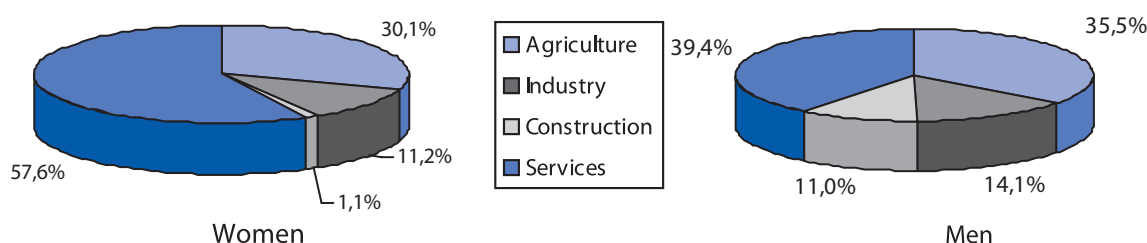

Depending on the economic activities, the gender distribution of the employed population remains corresponding to the traditional segregation on the labour market: the majority of women work in the public administration, education, health and social assistance sectors, followed closely by the trade and hotels and restaurants sectors, while men work mostly in construction, industry, services and agriculture.

According to occupation groups, the gender structure of the employed population depending on the area of residence is the following:

- the majority of women from rural areas are highly skilled specialists and workers in the services, housing and communal services, trade and similarities; in rural areas, most of the women are skilled employees in agriculture, forestry, game, fish breeding and fishing.
- most of the men are referred to the other occupation category, skilled workers in big and small industry enterprises, in manual work, constructions, transports, telecommunications, geology and geoexploration and leaders of public authorities at all levels, directors and higher servants from economic social and political units.
- at the level of the employed population, more men than women are unskilled workers.

6.10. Employed population by occupation group

Thousand persons

	2006				2007			
	Urban		Rural		Urban		Rural	
	W	M	W	M	W	M	W	M
Employed population, total	271,8	289,1	356,9	339,4	277,7	271,0	348,0	350,6
Leaders of public authorities of all levels, directors and higher servants from economic social and political units	24,1	42,9	10,3	11,3	23,6	38,1	9,6	11,4
Highly skilled specialists	71,3	51,1	35,4	14,0	72,6	44,5	31,3	12,9
Medium skilled specialists	37,5	20,1	29,3	10,8	41,3	16,2	30,7	9,2
Administrative servants	13,3	3,5	7,7	1,2	12,6	2,9	5,8	1,1
Employees in services, housing and communal services, trade and similarities	69,4	33,1	43,6	12,6	74,0	29,0	47,3	13,3
Skilled workers in agriculture, forestry, hunting, fish breeding and fishing	2,6	3,8	115,8	103,0	1,7	3,6	90,7	89,0
Skilled workers in large and small industrial enterprises, in handicraft, construction, transport, telecommunications, geology and geoexploration	17,3	53,2	16,5	32,5	17,8	52,9	15,4	37,7
Other occupations	36,3	81,4	98,4	154,1	34,1	83,8	117,2	175,9
of which, unskilled workers	32,0	34,0	96,7	111,9	29,7	35,8	114,9	131,2

Source: NBS, Labour Force Survey.

6.11. Employed population by professional status

Thousand persons

	2006				2007			
	Urban		Rural		Urban		Rural	
	W	M	W	M	W	M	W	M
Employed population, total	271,8	289,1	356,9	339,4	277,7	271,0	348,0	350,6
Employees	244,3	243,5	188,3	166,6	248,7	227,6	187,2	168,2
Employees in non-agricultural activities	241,1	236,6	154,8	107,8	246,0	222,0	158,2	114,7
Unemployed	27,5	45,6	168,6	172,9	29,0	43,3	160,8	182,4
Self-employed workers	23,6	37,3	142,2	161,8	24,3	37,4	140,0	173,5
Unpaid family workers	1,3	0,6	25,6	9,3	1,0	0,4	20,1	7,4

Source: NBS, Labour Force Survey.

Employed population by professional status, 2007

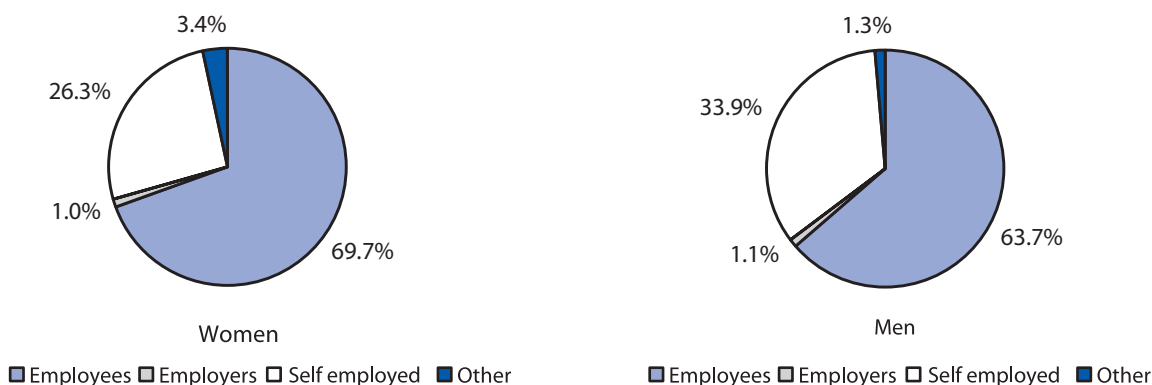

6.12. Employed population by ownership form

Thousand persons

	2006				2007			
	Urban		Rural		Urban		Rural	
	W	M	W	M	W	M	W	M
Employed population, total	271,8	289,1	356,9	339,4	277,7	271,0	348,0	350,6
Public	105,6	80,0	100,6	52,6	105,9	67,6	101,5	51,5
Private (including other forms of ownership)	166,2	209,1	256,3	286,9	171,7	203,4	246,5	299,0

Source: NBS, Labour Force Survey.

The last 2 years the biggest part of the employed population from the Republic of Moldova was employed (almost 70% of the women and more than 63% of the men). More men than women worked as self-employed workers (33,9% men and 26,3% women). With regard to the percentage of employers, it is very low and almost equal to the level of the entire female, respectively male employed population – nearly 1%.

But, when it comes to the population employed as unpaid family workers, women constitute the big majority, especially women from rural areas (16.300 women more than men from rural areas in 2006 and 12.700 more in 2007).

Although more persons work in the private than in the public sector, regardless of sex or area of residence, the number of women from the state sector is higher than that of the men, and the situation is opposite in the private sector. Again, this confirms once more the gender attitudes and relationships existing at the society level: women rather than men prefer the stability of the job, even if it is less remunerated (as it is more frequently the salary in the public sector) while men, rather than women, strive for a higher salary, even provided a greater instability of the job (as it happens frequently in the private sector).

6.13. Employed population by type of production unit

Thousand persons

	2006				2007			
	Urban		Rural		Urban		Rural	
	W	M	W	M	W	M	W	M
Employed population, total	271,8	289,1	356,9	339,4	277,7	271,0	348,0	350,6
Enterprises in the formal sector	259,2	264,0	231,5	217,9	266,6	246,4	228,2	222,1
Enterprises in the informal sector	7,9	23,1	39,7	55,4	7,5	22,8	39,5	60,4
Households	4,6	2,1	85,7	66,2	3,6	1,7	80,3	68,1

Source: NBS, Labour Force Survey.

Employed population by type of production unit

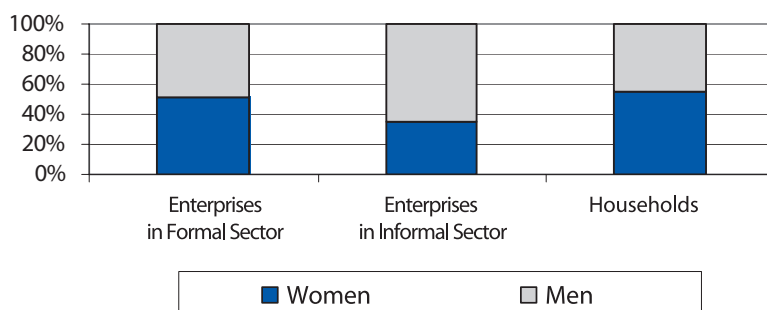

6.14. Employed population by type of occupation

Thousand persons

	2006				2007			
	Urban		Rural		Urban		Rural	
	W	M	W	M	W	M	W	M
Employed population, total	271,8	289,1	356,9	339,4	277,7	271,0	348,0	350,6
Formal occupation	227,0	224,6	178,0	186,2	214,6	234,2	186,9	192,1
Employees	203,1	207,1	126,3	156,6	193,0	214,2	132,1	160,0
Unemployed	23,9	17,4	51,7	29,6	21,5	20,1	54,8	32,0
Informal occupation	62,1	47,2	161,4	170,7	56,4	43,4	163,7	155,9
Employees	40,4	37,2	40,3	31,7	34,6	34,5	36,1	27,2
Unemployed	21,7	10,0	121,2	139,0	21,8	8,9	127,6	128,8

Source: NBS, Labour Force Survey.

Distribution of the informally employed population by sex and level of education

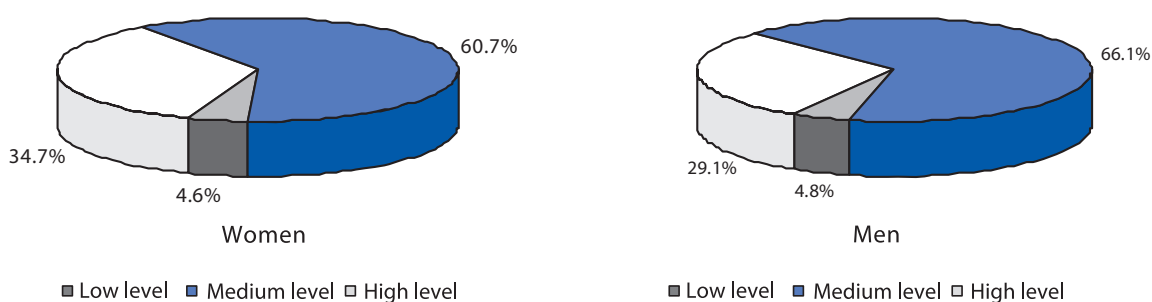

The gender distribution of the employed population by type of the production unit remained relatively the same during the last 2 years, thus:

- in the formal sector, the percentage of women and men is nearly the same (about 50%)
- the informal sector employs more men than women (nearly 35% women and 65% men)
- in households the above percentage is almost exactly the opposite, more than a half are women (nearly 55% women and 45% men).

The majority of population is employed in formal activities, from which they receive remuneration. Nevertheless, more women than men from this category are not remunerated and the gender gap is deeper in rural areas.

With regard to informal occupations, in the urban area, more women than men are referred to this category. The gender gap appears in the case of the population engaged in informal non-remunerated occupations, by area of residence: in urban areas more women than men are in this situation, in rural areas the situation is exactly opposite.

According to sex and level of education, almost 6% more men than women with a medium education level are employed in the informal sector, while women with a low level of education employed informally are nearly 5% more than men from the same category.

6.15. Number of employees by economic activity

at the end of year, thousand persons

	2006		2007	
	W	M	W	M
Employees, total	395,8	371,6	397,7	370,4
Agriculture, hunting and forestry	39,0	58,6	33,3	51,8
Fishing	0,1	0,5	0,1	0,6
Industry	68,0	73,5	69,5	73,1
Constructions	5,3	25,8	5,4	26,7
Wholesale and retail trade; repairs of cars, motorcycles, personal and household goods	46,1	46,3	48,8	49,5

	2006		2007	
	W	M	W	M
Hotels and restaurants	8,9	3,9	9,5	3,9
Transports and communications	18,8	38,6	18,9	39,6
Financial activities	8,2	4,5	9,6	5,3
Real estate	19,9	25,2	19,9	25,4
Public administration	22,9	34,7	23,0	34,4
Education	93,7	32,0	93,7	32,8
Health and social assistance	49,8	14,1	50,8	13,8
Other activities related to group, social and personal services	15,1	13,9	15,2	13,5
Recreational, cultural and sports activities	9,5	7,5	9,6	7,5

Source: NBS, Statistical surveys on the number and the remuneration of the employees in economic and social units employing 20 and more employees and on the staffing and workplaces at economic units employing up to 20 employees.

The data on the personnel by economic activity show once again the existing gender segregation on the labour market in a horizontal approach. Most of the women work in education, processing industry (especially in food and textile industry), health and social assistance and trade, while men work mostly in industry, agriculture, trade and repairs, transports and communications and public administration.

The distribution of the employees in a territory profile shows that the most part of the employees, regardless of sex, is in the city of Chisinau, followed by the North, Centre, South regions and ATU Gagauzia. If in the city of Chisinau there are more men than women in terms of the number of employees, in the rest of the regions, there are more women than men in terms of the number of employees. The situation is the same for the rest of localities from each region, except for Basarabeasca from the South region.

6.16. Number of employees in agriculture and industry

at the end of year, thousand persons

	2006		2007	
	W	M	W	M
Agriculture	37,4	54,8	31,5	47,4
Plant Growing	30,7	41,5	26,4	35,6
Animal Breeding	1,3	1,8	0,9	1,6
Plant Growing Associated To Animal Breeding	3,3	5,0	2,2	3,7
Services For Agriculture And Services In Animal Breeding (Except For Veterinary Services)	1,2	3,6	1,0	3,2
Forestry, Forest Exploitations And Supplementary Services	0,9	2,9	1,0	3,3
Industry	61,0	61,8	62,1	61,0
Extractive Industry	0,3	2,4	0,4	2,7
Processing Industry	56,1	46,1	57,1	45,0
Food And Drink Industry	20,2	20,7	19,7	19,8
Tobacco Industry	0,9	0,8	0,8	0,8
Textile Production	2,9	1,0	2,7	1,0
Clothing Industry; Furs Preparation And Dyeing	18,3	1,8	19,5	2,2
Leather Manufacture, And Shoe Making	3,1	0,9	3,5	1,1
Wood Industry And Manufacture	0,3	1,0	0,3	0,9
Paper And Carton Production	0,6	0,9	0,7	1,0
Editing, Polygraphy And Reproduction Of Informative Materials	1,2	1,0	1,1	0,8
Coal Carbonization, Oil Processing And Treatment Of Nuclear Fuels	0,0	0,1		
Chemical Industry	0,7	0,8	0,7	0,7
Production Of Rubber And Plastic Products	0,5	1,2	0,5	1,3
Production Of Other Non-Ferrous Metal Products	2,0	4,8	1,7	4,8
Metallurgic Industry	0,0	0,1	0,1	0,1
Manufacturing Of Metallic End Products, Except For The Production Of Machines And Equipment	0,5	1,8	0,5	2,1
Manufacturing Of Machines And Equipment	1,6	4,1	1,4	3,8
Manufacturing Of Office And Computing Machinery	0,2	0,3	0,2	0,2
Manufacturing Of Machines And Electric Devices	0,3	0,8	1,0	0,7
Radio, Tv And Communication Equipment And Devices Production	0,2	0,3	0,1	0,2

	2006		2007	
	W	M	W	M
Medical Devices And Instruments Production, Accuracy, Optics And Clockworks	1,0	1,1	0,9	1,0
Production Of Road Transport Facilities	0,0	0,0	0,0	0,0
Production Of Other Transport Facilities	0,0	0,2	0,0	0,1
Furniture Production Or Other Industrial Activities	1,5	2,1	1,6	2,1
Collection Of Remnants Of Recyclable Materials	0,1	0,3	0,1	0,3
Electric And Thermal Energy, Gas And Water	4,6	13,3	4,6	13,3
Production And Distribution Of Electric And Thermal Energy, Gas And Hot Water	3,4	9,8	3,3	9,8
Intake, Purification And Distribution Of Water	1,2	3,5	1,3	3,5

Source: NBS, Statistical survey on the number and the remuneration of employees in economic and social units employing 20 and more employees. At the same time, it covers all state budget-funded institutions, irrespective of the number of employees

6.17. Number of employees by location

at the end of year, thousand persons

	2006		2007	
	W	M	W	M
Employees, total	395,8	371,6	397,7	370,5
Mun. Chisinau	168,2	176,6	171,8	180,3
North	92,9	77,1	92,0	75,6
mun. Balti	23,2	20,9	24,6	22,0
Briceni	4,7	3,4	4,5	3,6
Donduseni	3,3	3,1	3,3	3,0
Drochia	8,4	7,7	7,8	7,1
Edinet	7,0	6,3	7,0	5,9
Falesti	7,3	5,3	7,0	4,8
Floresti	7,2	5,9	7,0	5,6
Glodeni	5,3	4,4	5,2	4,3
Ocnita	4,2	3,6	4,0	3,3
Riscani	6,3	4,5	5,8	4,3
Singerei	7,1	5,2	7,0	4,7
Soroca	8,9	6,8	8,8	7,0
Centre	71,6	57,3	71,6	56,4
Anenii Noi	6,3	5,7	6,3	5,7
Calarasi	4,4	3,6	4,6	3,6
Criuleni	4,5	3,3	4,6	3,2
Dubasari	2,5	2,2	2,4	2,2
Hincesti	8,8	7,5	8,5	7,0
Ialoveni	6,5	5,3	6,2	5,0
Nisporeni	3,2	2,6	3,4	2,5
Orhei	9,3	7,2	9,5	7,5
Rezina	4,0	3,2	4,0	3,2
Straseni	5,8	4,8	5,8	4,9
Soldanesti	2,8	2,0	3,0	2,0
Telenesti	5,3	3,6	5,0	3,5
Ungheni	8,2	6,3	8,3	6,1
South	42,9	38,4	42,5	36,6
Basarabeasca	2,9	4,1	2,7	3,8
Cahul	11,7	9,0	11,6	8,9
Cantemir	4,7	3,3	4,7	3,3
Causeni	5,8	4,8	5,8	4,5
Cimislia	4,2	4,5	4,2	4,3
Leova	3,3	2,3	3,3	2,3
Stefan Voda	5,1	5,0	5,0	4,7
Taraclia	5,2	5,4	5,2	4,8
ATU Gagauzia	17,1	14,9	17,0	14,1

Source: NBS, Statistical survey on the number and the remuneration of employees in economic and social units employing 20 and more employees. At the same time, it covers all state budget-funded institutions, irrespective of the number of employees.

6.18. Vocational training of employees

thousand persons

	2006		2007	
	W	M	W	M
Employees, total	25,0	27,5	29,8	28,7
Agriculture, hunting and forestry	0,1	0,2	0,1	0,2
Fishing	0	0,0	0,0	0
Industry	4,7	7,6	5,2	7,5
Constructions	0,1	1,5	0,1	1,6
Wholesale and retail trade; repairs of cars, motorcycles, personal and household goods	1,0	2,0	1,1	2,9
Hotels and restaurants	0,3	0,2	0,2	0,1
Transports and communications	3,4	5,7	3,5	5,5
Financial activities	2,4	1,7	3,2	1,6
Real estate	0,8	1,9	1,1	2,3
Public administration	1,5	3,4	2,0	3,3
Education	4,4	1,3	5,5	1,2
Health and social assistance	5,9	1,5	7,3	1,9
Other activities related to group, social and personal services	0,3	0,4	0,4	0,3
Recreational, cultural and sports activities	0,2	0,2	0,3	0,3

The concept of continuous education becomes more and more prominent in the day-to-day life of everybody, and, in this context, the vocational training of employees is one of the most important components of this concept.

The data from the table on vocational training of employees shows a dynamic of the gender relationships, i.e. if in 2006 2.5 thousand more men than women benefited from vocational training, in 2007 women compensated the difference, and even surpassed the number of men with 1100 persons.

With regard to economic activity fields, the beneficiaries of vocational training follow the same structure as in the gender segregation of the labour market:

- most of the women beneficiaries of vocational training work in health care and social assistance and in education;
- most of the men beneficiaries of vocational training work in industry, transports and communications

UNEMPLOYMENT

6.19. ILO unemployed by age group

thousand persons

	2006				2007			
	Urban		Rural		Urban		Rural	
	W	M	W	M	W	M	W	M
ILO unemployed, total	21,5	35,3	16,7	26,3	15,8	24,9	9,3	16,6
15–24 years	4,7	8,0	6,2	8,4	4,4	6,4	3,8	5,7
25–34 years	4,9	8,8	3,3	6,5	3,7	5,5	2,1	4,1
35–44 years	5,5	7,7	3,4	6,0	3,4	5,0	1,8	3,4
45–54 years	5,3	7,7	3,3	4,5	3,6	5,0	1,4	2,7
55 +	1,2	3,1	0,5	0,9	0,8	3,0	0,2	0,7

Source: NBS, Labour Force Survey.

ILO unemployed by age group

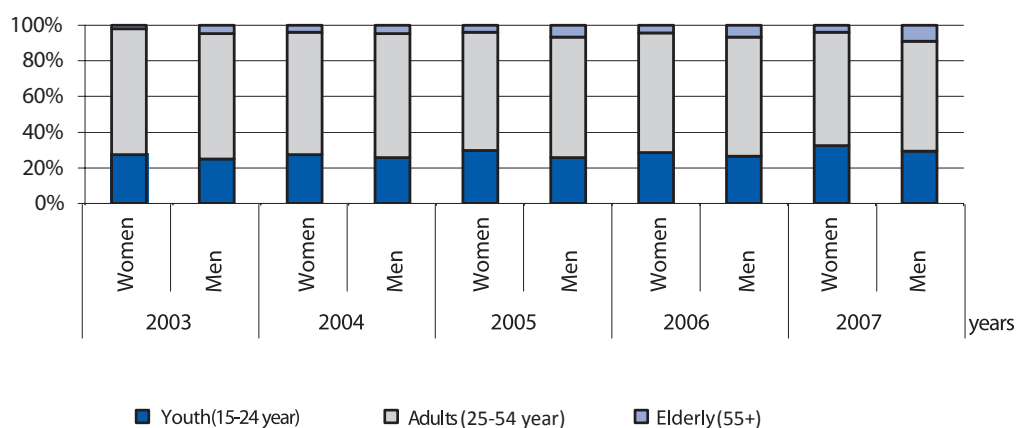

6.20. ILO unemployment rate by age group

percent

	2006				2007			
	Urban		Rural		Urban		Rural	
	W	M	W	M	W	M	W	M
ILO unemployed, total	7,3	10,9	4,5	7,2	5,4	8,4	2,6	4,5
15–24 years	18,4	20,7	14,4	16,0	16,4	16,6	11,7	13,4
25–34 years	7,5	10,3	5,3	10,5	5,5	7,4	3,6	6,5
35–44 years	7,7	10,9	3,5	6,9	4,4	7,4	1,9	4,0
45–54 years	5,3	9,1	3,1	4,5	4,0	6,8	1,3	2,6
55 +	3,7	7,0	0,7	1,4	2,4	7,2	0,3	0,9

Source: NBS, Labour Force Survey.

ILO unemployment rate by age group

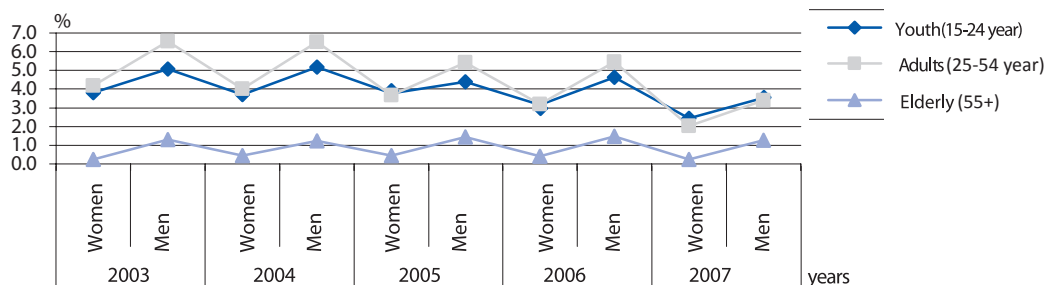

The unemployment rate is lower among women than among men during both analyzed years, within urban area, as well as within rural area. Regardless of sex, the unemployment rate decreased in 2007 compared with 2006. It is interesting to observe that in 2007 the unemployment rate for women from rural areas almost halved. But, the causes of this phenomenon should be thoroughly analyzed through quantitative and qualitative studies, since this can be also caused by the fact that the inactivity rate of women from rural areas is increasing, as well as the percentage of elderly women, which means that the decrease of the unemployment rate for women from rural areas is not due to some more active employment policies, but due to the fact that more women got to the retirement age and others became housewives.

As for the classification of unemployment by age group, the highest unemployment rate, regardless of sex, area of residence and year is for the level of the age group of 15-24 years. Thus, the young people are the most affected by the unemployment.

In the period 2003–2007 the unemployment rate fluctuated slightly, and had a more visible decrease in 2007. The gender difference maintained the same for the whole mentioned period and regardless of the age group: more men than women are unemployed.

6.21. ILO unemployed persons by education

thousand persons

	2006				2007			
	Urban		Rural		Urban		Rural	
	W	M	W	M	W	M	W	M
ILO unemployed, total	21,5	35,3	16,7	26,3	15,8	24,9	9,3	16,6
Higher	5,1	6,1	0,9	1,2	4,4	6,0	0,8	1,3
Vocational	4,7	7,0	2,2	2,0	2,1	3,6	1,7	1,2
Secondary vocational	4,4	10,7	3,1	7,1	3,4	7,6	1,4	4,2
Lyceum, general school	4,8	7,4	5,0	6,7	4,0	5,0	2,4	3,7
Gymnasium	2,5	3,9	5,4	8,9	1,8	2,6	3,0	5,7
Elementary or without education	0,0	0,3	0,2	0,5	0,1	0,0	0,1	0,5

Source: NBS, Labour Force Survey

ILO unemployed persons by education

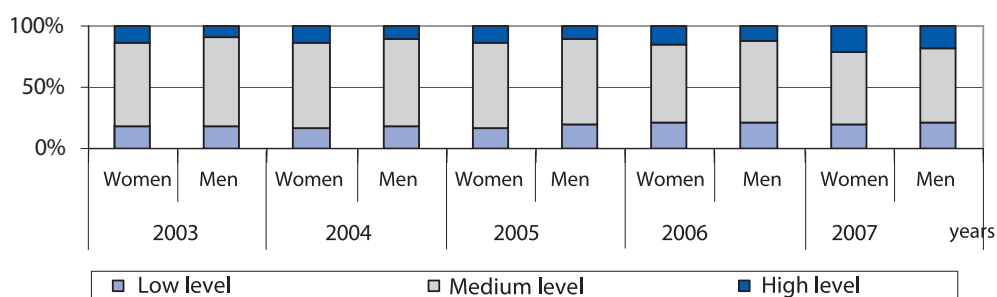

6.22. ILO unemployed rate by education level

percentage

	2006				2007			
	Urban		Rural		Urban		Rural	
	W	M	W	M	W	M	W	M
ILO unemployed, total	7,3	10,9	4,5	7,2	5,4	8,4	2,6	4,5
Higher	4,9	5,8	2,3	4,7	4,2	6,4	2,1	5,2
Vocational	6,9	13,3	3,2	5,0	2,9	8,3	2,6	3,0
Secondary vocational	8,1	12,0	5,0	6,2	6,6	8,9	2,2	3,4
Lyceum, general school	9,9	13,3	5,4	8,7	8,4	9,3	2,6	5,0
Gymnasium	14,4	18,4	5,6	9,3	11,1	14,0	3,4	6,1
Elementary or without education	0,0	35,6	1,0	3,9	17,9	4,2	0,6	4,5

Source: NBS, Labour Force Survey

ILO unemployed rate by education level

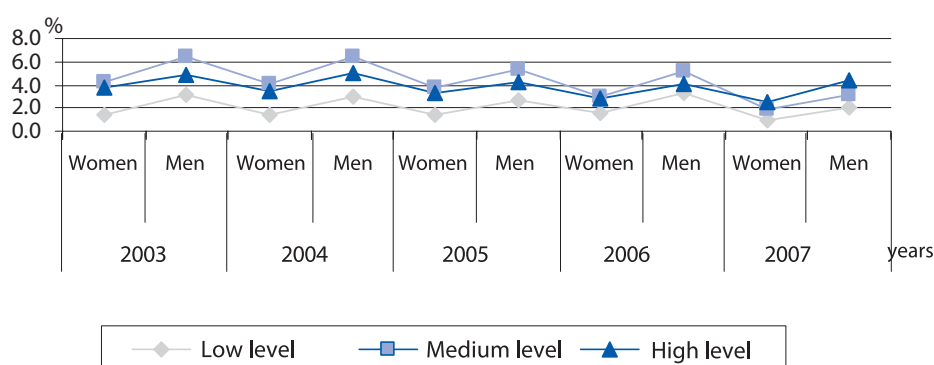

While analyzing unemployment rate by education level, we see that during 2003-2007 the majority of unemployed people, regardless sex and area of residence, are persons with medium education, and the fluctuations along years are insignificant.

It is interesting to see that in 2007 compared with 2006 the unemployment rate generally decreased in case of women, as well as in case of men, regardless the area of residence, with two notable exceptions:

- the unemployment rate among men with high education increased in 2007 compared with 2006;
- the unemployment rate of women with elementary or without education from urban areas increased from 0%¹¹ in 2006 to 17,9% in 2007.

6.23. ILO unemployed by length of unemployment

thousand persons

	2006				2007			
	Urban		Rural		Urban		Rural	
	W	M	W	M	W	M	W	M
ILO unemployed, total	22	35	17	26	16	25	9	17
under 3 months	4	7	5	7	3	6	3	6
3- 5 months	4	8	5	6	3	5	2	4
6 – 11 months	5	6	3	4	3	4	1	3
12 – 23 months	3	5	1	4	3	4	1	2
24 months and over	6	9	3	6	3	6	2	3
The average length of unemployment	25	22	17	18	21	20	20	16

Source: NBS, Labour Force Survey

ILO unemployed by length of unemployment

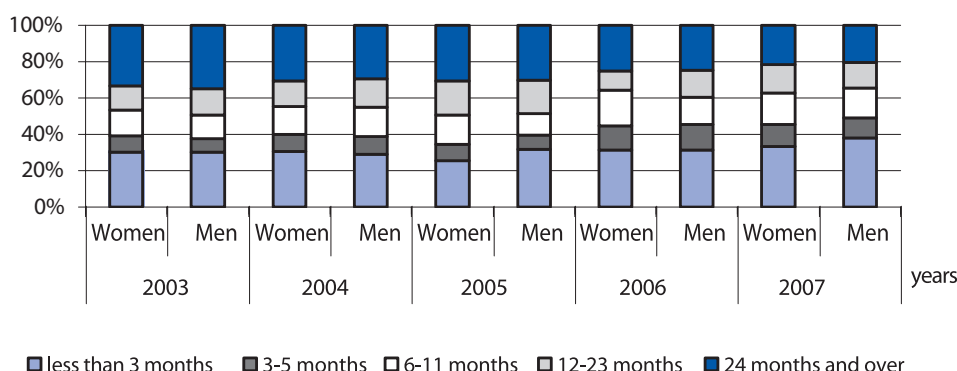

6.24. The long-term unemployment rate by age group

percentage

	2006		2007	
	W	M	W	M
Long-term unemployment rate (12 months and over), total	2.0	3.5	1.4	2.2
15–24 years	3.3	5.0	2.7	3.3
25-34 years	2.4	3.8	1.3	2.1
35-44 years	2.5	3.7	1.5	1.9
45–54 years	1.6	3.4	1.5	2.2
55 +	1.0	2.1	0.7	1.7

Source: NBS, Labour Force Survey

¹¹ An explanation of the 0% rate may be that most women with primary education or without education are housewives.

The long-term unemployment is decreasing, regardless of the sex and area of residence of the unemployed, both in 2007 compared to 2006, and during the whole period between 2003-2007. Most of the unemployed are in this situation for a period of less than 3 months. Nevertheless, except only 2003, a larger number of women than men entered the category of long-term unemployed (24 months and over). Long-term unemployment is highest between young people of 15-24 years age group, regardless of sex.

6.25. Unemployment among young people aged 15-24 years

percent

	2006		2007	
	W	M	W	M
ILO unemployed among 15 – 24 year-old, thousand persons	10,9	16,4	8,2	12,1
Share of unemployed young people in total unemployed	28,4	26,6	32,4	29,3
Share of unemployed young people in total population aged 15 – 24 years	3,2	4,6	2,4	3,5
Unemployment rate of young people	15,9	18,0	13,8	14,9
Ratio between the unemployment rates of young people and adults	2,8	2,0	3,5	2,4
Incidence of long-term unemployment between young people (share of 6 months and longer unemployment in total youth unemployment)	43,3	48,1	19,4	22,0

Source: NBS, Labour Force Survey

Unemployment among young people aged 15-24 years

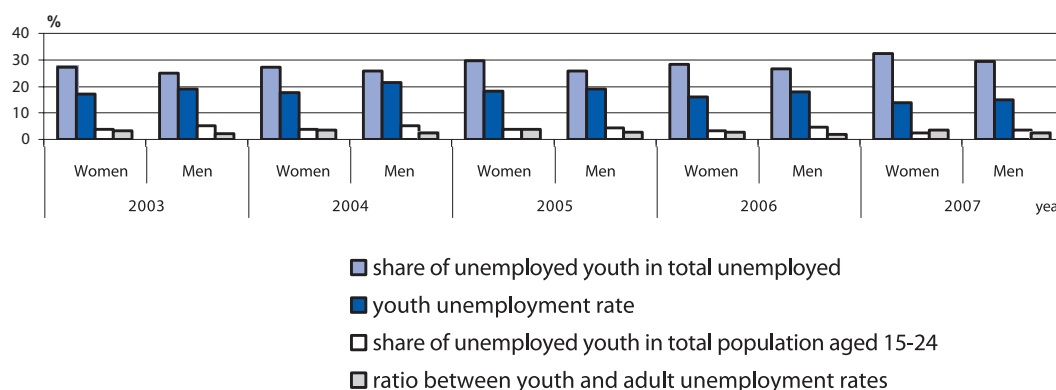

Although the unemployment rate among young people aged 15-24 years decreased slightly in 2007 compared to 2006 (the level of women of this age group decreased by 2 percent and the level of men by 3 percent), the rate of unemployment between young people in total is increasing and is higher as in the case of women than in that of men, exactly as it is in the case of relationship between the rate of unemployment of young people and adults.

Concerning the incidence of long-term unemployment (6 months and over) among young people, this reached an alarming rate in 2006 (over 43% for women and over 48% for men). The data show a decrease with more than a half of this phenomenon in 2007. Exactly as it is the case of decreasing by half of the unemployment rate among women from rural areas (see the Table 17 and the explanations enclosed), we shall not be in a hurry with a conclusion in this case as well. The causes of the phenomena should be thoroughly studied additionally, as there can be another explanation of this thing, which will not be related to the improvement of the employment policies (like international migration or increase of economic inactivity rate – more women than men become housewives or take the child care leave).

6.26. Unemployed registered at employment agencies by age group

during the year, thousand persons

	2006				2007			
	Unemployed registered		Unemployed provided with jobs		Unemployed registered		Unemployed provided with jobs	
	W	M	W	M	W	M	W	M
Unemployed, total	24,5	27,3	12,8	11,1	24,3	24,1	13,0	10,3
16–24 years	8,9	6,7	4,7	3,4	8,2	5,5	4,8	2,8
25–29 years	3,5	5,2	2,0	1,8	3,3	3,8	1,7	1,5
30–49 years	9,3	12,1	5,0	4,2	9,6	11,1	5,2	4,1
50–65 years	2,8	3,3	1,1	1,7	3,2	3,7	1,3	1,9

Source: National Employment Agency (NEA)

6.27. Unemployed registered by employment agencies, by level of education

during the year, thousand persons

	2006				2007			
	Registered unemployed		Unemployed provided with jobs		Registered unemployed		Unemployed provided with jobs	
	W	M	W	M	W	M	W	M
Unemployed, total	24,5	27,3	12,8	11,1	24,3	24,1	13,0	10,3
Higher	2,5	1,8	1,2	0,8	2,2	1,5	1,2	0,7
Vocational	2,8	2,1	1,4	0,9	2,7	1,7	1,4	0,8
Secondary vocational	4,8	8,5	2,8	3,6	4,8	7,6	2,6	3,2
Lyceum, general school	7,3	6,7	4,0	3,1	7,9	6,4	4,5	3,2
Gymnasium	7,1	8,2	3,3	2,6	6,7	6,9	3,4	2,4
Elementary or without education	–	–	–	–	–	–	–	–

Source: National Employment Agency (NEA)

The number of unemployed registered with employment agencies slightly decreased in 2007 compared to 2006, the decrease being insignificant at the level of women, while being of 3% between men. Of these, if in 2006 there were more men than women, in 2007 the registered number of unemployed women was almost equal to that of men. Nevertheless, during both years more women than men were employed (more than a half of registered unemployed women).

6.28. Vocational training of registered unemployed

persons

	2006		2007	
	W	M	W	M
Unemployed who graduated from training courses, total	3421	1208	3551	1065
Training	2329	939	2462	823
Re-training	818	191	790	198
Advanced training	274	78	299	44
Employed, total	1454	557	2550	875
By confirmation	1454	557	1825	519
Independently	820	354	725	356

Source: National Employment Agency (NEA)

The data on the vocational training of unemployed registered with the employment agencies shows that twice more women than men graduated training courses (training, re-training, advanced training). In consequence, more women than men of this category were employed.

However, if we are to analyze the rate of women employed out of the total unemployed women who graduated training courses, compared to the same rate at men's level, we see that in 2006 only 66,5% of unemployed women who undertake training courses were employed, compared to 75% of men, while in 2007 the difference reaches 10% (71,8% of unemployed women who undertake training courses were employed compared to 82,2% men).

WORKING CONDITIONS

6.29. Harmful and dangerous factors¹ to which employees are exposed

thousand persons

	2006		2007	
	W	M	W	M
People working in harmful or dangerous conditions, total	84.3	113.4	73.2	94.8
including harmful or dangerous factors:				
Physical (noise, dust, gases, work on heights, humidity, vibration, temperature, radiation, etc.)	50.6	77.5	38.5	63.2
Chemical (Toxic, irritating, carcinogenic, mutational action, etc.)	12.8	14.1	12.1	12.2
Biological (bacteria, insects, viruses etc.)	3.8	0.9	3.0	0.5
Psycho physiological (intellectual, neural overstress, monotone operations, etc.)	17.2	20.9	19.7	18.9

¹ As reported by respondents

Source: NBS, Labour Force Survey

6.30. Working conditions of employees by economic activity in 2007

during the year, persons

	Persons working in conditions that do not meet the hygiene and health standards		Persons involved in hard physical work		Persons working in premises that do not meet the standards for safety at work		Persons working with machinery that does not meet the standards for safety at work	
	W	M	W	M	W	M	W	M
Employees, total	8263	10105	179	1482	58	77	10	79
Agriculture, hunting and forestry	143	515	89	156	3	36	–	5
Industry – total	3534	6068	53	903	–	8	–	69
extractive industry	18	751	–	276	–	–	–	61
processing industry	3114	3648	51	507	–	–	–	–
electric and thermal energy, gas and water	402	1669	2	120	–	8	–	8
Construction	27	338	9	81	–	–	–	–
Wholesale and retail trade; repairs of cars, motorcycles, household and personal goods	56	55	–	50	–	–	–	–
Transport and communications	174	1334	–	182	–	4	–	–
Real estate transactions	239	287	7	17	–	–	10	1
Education	2208	588	8	13	13	4	–	–
Health and social assistance	1018	345	9	26	42	17	–	4
Other activities	864	575	4	54	–	8	–	–

Source: NBS, Statistical survey on labour protection in economic and social units employing 20 and more employees. At the same time, it covers all state budget-funded institutions, irrespective of the number of employees.

Other: Fishing, Hotels and restaurants, Financial activities, Public administration, Other service activities.

Although the number of employees working in harmful or dangerous conditions registers a slight decrease in 2007 compared to 2006, at the level of both years more men than women are in this situation (with 29 thousands more men than women in 2006 and with 21,6 thousands more in 2007).

Depending on the type of conditions the most of these people, regardless of sex work in harmful or dangerous conditions determined by physical factors. However more men than women fell in this category,

while the number of women even decreased significantly in 2007 compared to 2006. Gender differences are much more insignificant when we refer to harmful and dangerous factors of chemical or psycho physiological nature. Moreover, in 2007 the number of women affected by psycho physiological factors overcame the number of men of this category.

Only in case of biological factors the number of affected women is higher than that of men, at the level of both years the difference being around 2500-3000 people.

As expected, per total less women than men work in working conditions that do not correspond to hygienic-sanitary requirements, are involved in heavy physical labour, work in inadequate premises or use equipment inadequate to labour safety requirements. However, if we consider the economic activities in which these people work we will see that the feminized economic areas, such as education and health and social assistance, the number of women working in inadequate conditions is higher than the number of men.

6.31. Facilities and supplements granted to employees for unfavourable working conditions by economic activity in 2007

during the year, persons

	Persons benefiting from:									
	Additional leaves		Shorter daily working time		Higher tariff salaries		Supplements for unfavourable working conditions		Right to preferential state pension	
	W	M	W	M	W	M	W	M	W	M
Employees, total	27608	22966	6266	1763	991	2175	35078	24571	172	561
Agriculture, hunting and forestry	344	565	–	53	32	42	111	694	–	4
Industry – total	6030	11595	215	517	164	652	5982	10746	39	515
extractive industry	81	1110	10	388	31	334	19	689	9	374
processing industry	4897	5721	200	91	133	280	5000	5708	30	141
electric and thermal energy, gas and water	1052	4764	5	38	–	38	963	4349	–	–
Construction	72	752	1	2	–	9	17	398	–	–
Wholesale and retail trade; repairs of cars, motorcycles, household and personal goods	412	829	150	12	32	18	304	1175	–	–
Transport and communications	779	3734	157	11	36	1300	459	2170	52	7
Real estate transactions	571	433	403	136	–	5	2226	1370	2	8
Education	2756	421	81	13	30	13	12768	3801	–	–
Health and social assistance	16336	4301	5240	1016	592	52	10842	2425	79	27
Other activities	308	336	19	3	105	84	2369	1792	–	–

Source: NBS, Statistical survey on labour protection in economic and social units employing 20 and more employees. At the same time, it covers all state budget-funded institutions, irrespective of the number of employees.

Other: Fishing, Hotels and restaurants, Financial activities, Public administration, Other service activities.

The gender analysis of the data related to allowances and salary supplements for work in dangerous conditions shows the following:

- more women than men benefit from additional leaves, reduced number of hours and allowances for work in dangerous conditions
- more men than women benefit from increased tariff salaries and rights to state pension for working in dangerous conditions

In conclusion, we may say that women rather benefit from allowances for work in dangerous conditions, while men benefit from more salary supplements and monetary compensations.

6.32. Labour accidents by economic activity

during the year, persons

	2006				2007			
	Total, persons		Per 10000 employees		Total, persons		Per 10000 employees	
	W	M	W	M	W	M	W	M
Accidents, total	179	451	5,246	15,258	149	401	4,373	13,643
of which lethal accidents	3	28	0,047	0,101	2	38	0,059	7,957
Agriculture, hunting and forestry, total	13	29	3,455	5,287	7	32	2,236	6,700
of which lethal accidents	1	3	0,266	0,547	–	1	–	0,209
Industry, total	72	207	11,361	33,055	52	181	8,069	29,413
of which lethal accidents	–	2	–	0,319	1	13	0,155	2,113
Construction, total	2	47	6,798	27,766	2	47	6,329	26,415
of which lethal accidents	–	9	–	5,317	–	11	–	6,182
Transport and communications, total	10	47	6,148	14,882	11	32	6,751	9,885
of which lethal accidents	–	3	–	0,950	–	3	–	0,927
Other activities, total	82	121	3,710	9,337	77	109	3,778	10,668
of which lethal accidents	2	11	0,090	0,849	1	10	0,049	0,979

Source: NBS, Statistical surveys on labour protection in economic and social units employing 20 and more employees. At the same time, it covers all state budget-funded institutions, irrespective of the number of employees.

Labour accidents also appear more often in case of men than women, especially in cases of deadly accidents. In 2007 is registered a slight decrease in labour accidents, however the number of deadly accidents among men increased with 26% (as compared to 2006, 10 more men died in labour accidents).

LABOUR REMUNERATION

6.33. Average salary in September by economic activity

lei

	2006		2007	
	W	M	W	M
Employees, total	1472,7	2162,6	1808,6	2489,9
Agriculture, hunting and forestry	848,9	1031,9	1140,3	1352,6
Fishing	1267,7	1182,8	1650,0	1297,6
Industry	1951,3	2577,8	2136,9	2965,4
Construction	2112,2	2851,0	2832,0	3529,3
Wholesale and retail trade; repairs of cars, motorcycles, household and personal goods	1392,3	1749,9	1852,8	2278,6
Hotels and restaurants	1416,3	1885,3	1730,6	2421,8
Transport and communications	2316,3	2808,0	2896,1	3243,5
Financial activities	2926,6	3418,0	3330,0	4400,9
Real estate transactions	1970,5	2289,4	2690,5	2857,4
Public administration	1950,8	3200,0	1934,7	2457,4
Education	1136,3	1319,6	1411,9	1721,6
Health and social assistance	1205,4	1642,6	1649,8	2247,1
Other activities related to group, social and personal services	1119,1	1512,1	1466,2	1966,8
Recreational, cultural and sports activities	928,6	1236,9	1240,2	1718,5

Source: NBS, Statistical survey on distribution of employees by size of salary calculated for September in economic and social units employing 20 and more employees. At the same time, it covers all state budget-funded institutions, irrespective of the number of employees.

The data regarding labour remuneration shows that in 2006 women earned on average with 32% less than men (only 68% of the average salary of men). In 2007 the difference decreased under 30%, reaching the 27,36% (women earned 73,64% of the average salary of men).

If we look at the average differences in wages by economic activity, we see that in absolutely all economic activities, in both analyzed years, women have lower income than men. The only exception is the fishing field, where women received in 2006, on average, with 7% more than men and in 2007 the difference increased to 21%. However, we should remind the fact that the number of persons that work in fishing field is very small, and the number of women is very small, being only of 100 women¹². The difference of wage to the prejudice of women is maintained including in those economic fields where women are the majority of employees, as education, health and social assistance.

The largest difference in average remuneration between women and men was registered in 2006 in the field of public administration, where women earned with almost 40% less than men. In 2007 this enormous difference has reduced to 21%, under the annual average figure. It is interesting to see that in this field the average salary decreased in 2007 compared to 2006, of women with only 16 lei on average, while that of men decreased with 743 lei. Actually it is the only economic sector where the salaries have decreased in 2007 compared to 2006. For the determination of causes is necessary a thorough analysis of changes in policies in the field that took place in 2007 as well as the disaggregated statistic data depending on sex by hierarchic levels and positions.

If we are to analyze the best remunerated fields compared to those worst remunerated, we will see the following:

- The largest salaries are earned in financial activity sector, where the average salary difference between men and women increased in 2007 compared to 2006 (from 14,4% to 24,4%);
- The lowest salaries are earned in agriculture where gender differences in remuneration are between 18-15%

6.34. Average salary in September, by location

lei

	2006		2007	
	W	M	W	M
Employees, total	1473	2163	1809	2490
Mun. Chisinau	1903	2638	2303	3093
North	1226	1843	1516	2191
mun. Balti	1648	2444	2061	2738
Briceni	982	2131	1270	1815
Donduseni	1143	1391	1487	2150
Drochia	1025	2015	1231	2212
Edinet	1133	1821	1448	1928
Falesti	1015	1291	1356	1466
Floresti	1159	1758	1449	1831
Glodeni	1012	1339	1207	1615
Ocnita	1055	1531	1226	1905
Riscani	988	1213	1290	1455
Singerei	1043	1156	1261	1393
Soroca	1265	1582	1476	2075
Centre	1215	1756	1477	1922
Anenii Noi	1213	2268	1580	2362
Calarasi	1293	1534	1569	1787
Criuleni	1153	1540	1340	1749
Dubasari	1171	1321	1376	1733
Hincesti	1035	1184	1343	1626
Ialoveni	1196	2143	1520	2235
Nisporeni	1078	1380	1337	1514
Orhei	1534	1904	1577	1953
Rezina	1324	2906	1644	2424
Straseni	1217	2021	1468	1901
Soldanesti	942	1222	1240	1621
Telenesti	1005	1145	1221	1390
Ungheni	1293	1752	1672	2082

¹² See Table 6.15 "Structure of employees by economic activity"

	2006		2007	
	W	M	W	M
South	1092	1667	1388	1717
Basarabeasca	1252	2383	1578	2624
Cahul	1273	1653	1606	1763
Cantemir	902	1270	1328	1303
Causeni	1056	1442	1347	1668
Cimislia	1014	1594	1267	1636
Leova	896	1672	1249	1469
Stefan Voda	982	1332	1258	1383
Taraclia	1151	1885	1231	1693
ATU Gagauzia	1112	1470	1432	1790

From the territorial point of view, the differences in the average salary between men and women ranged in 2006 between under 25% in ATU Gagauzia and over 34% in the South region (in Chisinau the difference was almost 28%). In 2007 on the level of all regions the difference decreased, ranging between under 20% in the South¹³ region and over 30% in the North region. In Chisinau the difference decreased with almost 3 percent, reaching over 25%.

6.35. Average monthly salary by some positions/professions and activities in October

lei

	2006		2007	
	W	M	W	M
Agriculture	848	955	975	1190
Worker in agricultural crop growing	929	852	1054	907
Horticulturist	1264	1241	1130	1156
Viticulturist	1039	967	1029	927
Tobacco grower	789	614	901	820
Floriculturist	2034	1835	1674	1825
Tractor driver	919	1104	763	1337
Production of bread and bakery products	1876	1945	2267	2323
Baker	1157	1292	1350	1681
Baker, mechanized line	1435	909	1750	1079
Production of dairy products	2003	1948	2464	2631
Operator, dairy product packaging machinery	2093	1837	2550	2156
Operator, automated line for production of dairy products	1084	2025	1527	2428
Operator, for production of cultured milk foods and dairy products for children	1918	2460	3085	-
Separator of milk and raw milk	1549	1555	1814	2671
Production, processing and canning of meat	1987	2296	1943	2547
Animal slaughter	1169	1451	1232	1617
Deboner	2626	1560	935	1527
Cutter of meat products	-	1892	2444	1328
Fillerman-packer	1868	2835	1849	2798
Operator, thermal treatment of meat products	1033	2843	1257	1706
Clothing industry	1569	1801	1917	2808
Tailor	1507	1631	1831	1835
Operator for sewing equipment (seamstress)	1519	1000	1729	2270
Manufacture of footwear	1729	1803	2020	2140
Tailor for materials	1983	1502	1833	2892
Operator, band conveyor	750	3400	2078	-
Operator, cloth-cutting machine	-	1087	-	1738
Shoe seamer	1614	1334	1640	1026
Furniture industry	1809	1667	2223	2376
Upholsterer, furniture	2588	1096	3464	1654
Material preparator for upholstering and revetment	2200	2181	3129	3140
Carpenter	2753	1766	2344	2558
Plater for furniture elements	1484	1038	1431	1343

¹³ The South region registered the highest decrease in the difference between the average salary of women and men (with over 15%).

	2006		2007	
	W	M	W	M
Finisher for woodwork	1485	1090	1620	2041
Manufacture of chemicals	1872	2576	2706	3691
Operator, mixing	880	1460	3576	2766
Operator, confectioner, laboratory assistant	1427	2264	2989	2619
Metalworking	1896	2361	2165	2808
Adjuster, automated lines and aggregate machine-tools	–	1043	–	1080
Adjuster, automated and semi-automated machinery	–	3448	–	3122
Gas welder	–	3031	–	1208
Electrical welder for manual welding	2790	2605	3100	2668
Electrical and gas welder	1200	2844	1200	2933
Electrical welder for automated and semi-automated machinery	–	2345	–	2766
Construction of machinery	1478	2133	2094	2612
Moulder for mechanical moulding	–	2041	–	3626
Metal caster	–	2150	–	3076
Sharpener	1094	1786	1866	2108
Moulder for metal moulds	–	1939	–	2224
Adjuster, automated lines and aggregate machine-tools	–	1633	–	4139
Operator, machines with programmed control	–	4001	–	3991
Locksmith, mechanical assembly works	2047	2432	2208	2807
Printing industry	2582	2521	2923	4204
Correspondent	1896	1806	2714	3004
Corrector	2236	2145	2379	1860
Editor	2405	3033	3552	2990
Artistic editor	800	1188	2022	1511
Technical editor	3951	1917	5764	1962
Typesetter	1952	–	1857	1500
Typist, machines	–	1151	4439	2175
Printer	2443	2856	3296	4348
Bookbinder	1917	–	2355	2143
Machinist, binding machines	2808	–	4608	900
Machinist, line setting machines	–	6702	–	5902
Production, collection and distribution of electricity	3264	3412	3840	4173
Electrician, maintenance of electric equipment from power plants	–	3023	–	4220
Electrician, repair of relay-based protection and automated equipment	2523	2810	3222	3623
Electrician, adjustment of air power lines	–	2362	–	3283
Electrician, supervision of cable networks	2754	2014	3303	3321
Controller, energy control	2210	2025	2809	2595
Construction	2176	2796	2751	3365
Painter-builder	2398	2746	2813	2791
Mason-builder	–	2783	–	3499
Blacksmith-concreter	3502	3112	2611	3987
Concreter	1757	2856	–	3516
Carpenter	–	2763	–	3480
Plasterer	2154	2581	3368	2896
Wholesale and retail trade	1273	1639	1715	2024
Cashier in trade rooms	1055	–	2074	900
Controller-cashier	909	709	1616	1095
Food seller	1001	961	1479	2140
Counter	900	2059	1988	2410
Merchandiser	2119	2019	2477	4203
Supply agent (manager)	1588	1602	2119	1753
Hotels and restaurants	1427	1932	1896	2348
Doorkeeper	3944	989	2575	1492
Registrar, administrator	1919	1388	2370	1983
Chef	994	998	1403	1553
Waiter	868	1107	1415	1710
Chambermaid (including senior), caretaker	1298	1306	1955	1210
Porter	3301	1057	–	1718

	2006		2007	
	W	M	W	M
Railway Transport	1576	2113	2354	3028
Cashier, tickets	1300	1210	1875	1821
Team leader, train	2330	2260	3393	2801
Train attendant	1595	1498	2206	2068
Inspector, inspector repairing railway carriages	2035	2088	2958	2747
Locksmith for repairs of locomotive rolling stock	1663	2089	2395	3165
Pointsman on duty	1256	1265	1710	1725
Passenger transport	1743	2053	2175	2592
Ticket controller (conductor)	2285	2044	3035	2484
Mechanic, locksmith	1100	2168	3201	2920
Bus driver	–	1144	–	1707
Trolley-bus driver	4451	4125	4940	4953
Air transport	2269	7218	6380	6957
Head-pilot of the flight team	–	10998	–	10834
Commander of airplane	–	16853	–	17186
Flight attendant (stewardess)	8078	7983	9284	8938
Flying mechanic	–	6763	–	6415
Communications	2545	4005	3326	5240
Mail sorter	1263	1335	2052	2338
Postman	603	845	938	1342
Telephone operator, interurban telecommunications	3079	–	3706	–
Telephone operator, information service of the urban telephone network	2816	–	3556	–
Education¹	1022	1068	1277	1325
Teachers of Language and Literature	1474	1542	1767	1922
Teachers of Mathematics	1603	1602	1922	1944
Teachers of technical subjects	1328	1314	1589	1618
General education teachers	1380	1349	1623	1635
Teachers for primary education	1385	1284	1710	1625
Educators	881	1283	1180	1507
University education	1864	2565	2065	2734
University professor	3203	3409	3547	4011
Associate professor (docent)	2826	2839	3353	3348
Senior university lecturer	2132	2314	2551	2701
University lecturer	1418	1537	1814	2008
Assistant professor	1712	1927	2137	2231
Health care	1241	1793	1678	1974
Therapists, district (GPs)	2083	2173	2798	3100
Therapists, hospitals	1680	2048	2201	2697
Surgeons	1848	2025	2309	2613
Dentists	1097	1037	1623	1966
Doctors, teams of emergency health stations (sections)	2507	2588	3071	3135
Paediatricians, districts	1630	2685	2225	4154
Paediatricians, hospitals	1702	1780	2392	2898
Physiotherapists	1629	2108	2091	2587
Nurses	1250	1251	1627	1580
Basic health staff	715	908	895	1057
Culture	895	1142	1215	1584
Journalists and related staff	2417	2310	2849	2878
Artists of various genres	1153	1195	1356	1400
Theatre actors and directors	1135	1234	1749	1986
Actors and directors of films and other shows	2106	1943	2311	2369
Librarians	746	712	1001	997
Archivists	777	–	778	567
Art managers	532	585	819	922

¹ Only university education

Source: NBS, Statistical survey on salary earnings of personnel specified by position in October (in economic and social units employing 20 and more employees). At the same time, it covers all state budget-funded institutions, irrespective of the number of employees.

7. EDUCATION

GENERAL BACKGROUND

7.1. Students by type of institution

thousand persons

	2006/2007		2007/2008	
	W	M	W	M
Primary and general secondary education institutions (day course)	245,7	245,8	230,5	230,5
Vocational secondary education institutions	8,4	15,3	8,4	16,1
Specialized secondary education institutions (colleges)	17,0	13,2	17,6	13,7
Higher education institutions	74,2	53,8	72,4	50,5

During the education year 2006–2007, the number of male students in primary and general secondary education exceeded by almost 100 persons the number of female students, and in the following year (2007/2008), their numbers became equal. In the vocational secondary education, the number of boys was twice higher than the number of girls. In terms of enrolment in the primary, general secondary and vocational secondary education, the share of boys aged between 7 and 16 was 98,8% of the total number of students in primary, general secondary and vocational secondary education institutions, while the share of girls was 99,7%, considering that at 1 January 2008, the male population aged between 7 and 16 inclusively constituted 249,5 thousand persons, while the female population was 239,7 thousand.

We find quite a different vocational orientation by sex. Boys enter vocational secondary education more than girls, who rather join specialized secondary or higher education, where their number is much higher than boys.

7.2. Teaching personnel by type of institution

thousand persons

	2006/2007		2007/2008	
	W	M	W	M
Primary and general secondary institutions (day course)	31,9	8,1	31,2	7,4
Vocational secondary education institutions	1,3	1,2	1,2	1,2
Specialized secondary education institutions (colleges)	1,4	0,6	1,4	0,6
Higher education institutions	3,6	3,0	3,5	2,9

7.3. Share of female teachers in the total number of teaching staff in 2007/2008

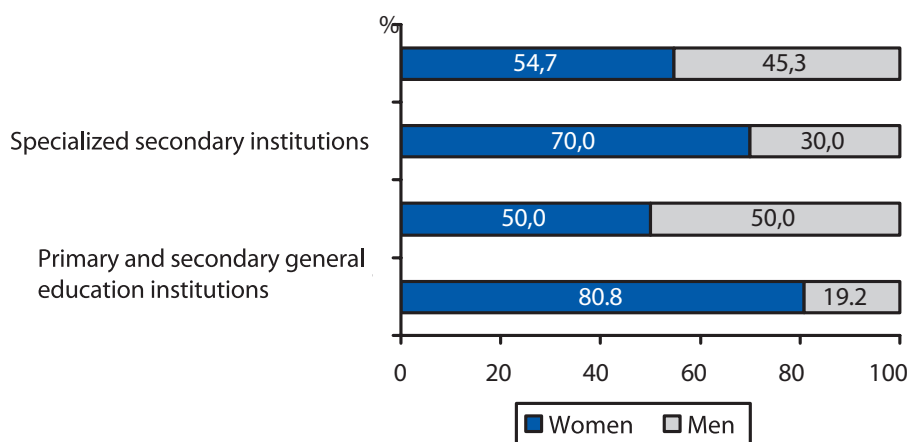

Education, in terms of labour market, is a strongly feminized field. Out of the total number of 49.4 thousand persons employed as teaching staff (in the education year 2007/2008), women constituted more than three quarters. Still, there are some differences between the education cycles, the biggest percentage of women as teaching staff is found in the primary and general secondary cycle (80,8%) and in colleges (70%), while in the vocational secondary and higher education there is a more balanced distribution by sex.

Compared to the education year 2006/2007, no major changes have taken place, except a 2% increase of men share in vocational secondary education and a 1,1% drop of that share among teaching staff in primary and secondary general education.

7.4. Enrolment rate by educational level, %

	2006/2007		2007/2008	
	W	M	W	M
Preschool education (level 0)				
Gross	69,5	70,8	72,0	73,2
Net	67,9	69,0	70,6	71,5
Primary education (level 1)				
Gross	93,6	95,2	93,0	95,0
Net	87,0	88,1	86,9	88,5
Lower secondary (gymnasium) education (level 2)				
Gross	90,1	90,9	89,8	90,3
Net	85,9	86,4	85,5	85,7

PRESCHOOL EDUCATION

7.5. Number of children in preschool institutions, by area of residence

thousand persons

	2006				2007			
	Urban		Rural		Urban		Rural	
	W	M	W	M	W	M	W	M
Total	25,9	28,0	29,8	32,5	26,6	29,2	31,0	33,3
including:								
kindergarten	1,1	1,2	12,3	13,7	0,8	1,0	11,8	12,8
nursery-kindergarten and nursery	24,0	26,0	17,2	18,6	25,0	27,3	18,9	20,3
school-kindergarten	0,8	0,8	0,3	0,2	0,8	0,9	0,3	0,2

7.6. Number of children in preschool institutions, by sex

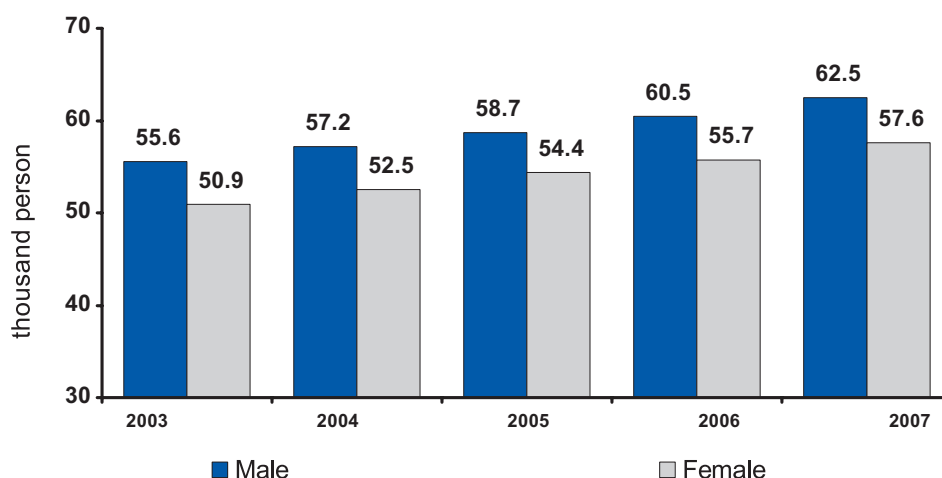

The number of children enrolled in preschool institutions, both boys and girls, is growing continually by 2-3 percent annually. However, the number of girls is constantly lower by about 5 thousand persons. This is not due to any discriminatory factors, but due to the smaller number of girls than boys in those age groups. In 2007, girls constituted 48% of the total number of children in preschool education, and among 2-6 year-old children, their share was 48,5%, which points to the fact that girls are covered by preschool education even to a greater extent than boys.

There are major differences in coverage of children by preschool education in urban and rural areas. Though we can see that the number of rural children covered by preschool education is higher than urban children (in 2007, 31 thousand girls and 33,3 thousand boys, compared to 26,6 thousand girls and 29,2 thousand boys in the urban areas), the ratio to the overall average numbers of children shows a very low coverage rate in rural areas, compared with towns. If we relate the number of children aged 2-6 to the number of children in preschool institutions, we find that in the urban area, around 85% of children attend preschool facilities, while in rural areas – only 54%.

7.7. Preschool institutions, by type and area of residence, 2007

thousand persons

	2006				2007			
	Urban		Rural		Urban		Rural	
	W	M	W	M	W	M	W	M
Total	25,9	28,0	29,8	32,5	26,6	29,2	31,0	33,3
including:								
kindergarten	1,1	1,2	12,3	13,7	0,8	1,0	11,8	12,8
nursery-kindergarten and nursery	24,0	26,0	17,2	18,6	25,0	27,3	18,9	20,3
school-kindergarten	0,8	0,8	0,3	0,2	0,8	0,9	0,3	0,2

The distribution of preschool institutions by types may shed some light both on the age, when children are included in preschool education, and on the available infrastructure at the preschool education level. In crèches or crèche-kindergartens, children are enrolled at younger age, while they start going to school-kindergartens at older age, right before primary school. And in this case, there are no major differences by sex, but this does not apply to their area of residence. Weighted in percentage, one may observe that in the urban areas crèches and crèche-kindergartens prevail, including some 94% of all children covered by preschool education, while in rural areas – only 61%.

A significant number of rural children attend kindergartens (lacking crèche groups) – 38,3%, while very few children (3% in total) go to this type of institution in the urban areas. School-kindergartens are the type of institution, which is rarely found both in towns and villages, but anyhow, there are more of them in the urban areas. Thus, this type of institution covers 3% of children in the urban areas and only 0,8% in the rural localities.

7.8. Preschool institutions by type and area of residence, 2007

	Number of pre-school institutions		Number of children, thousand persons.		Number of children per 100 places	
	2006	2007	2006	2007	2006	2007
Total	1305	1334	116,2	120,1	73	75
including:						
kindergarten	502	479	28,3	26,3	62	65
nursery-kindergarten and nursery	778	827	85,8	91,6	78	79
school-kindergarten	25	28	2,1	2,2	59	65
Urban	307	308	53,9	55,8	85	88
including:						
kindergarten	23	21	2,3	1,8	74	78
nursery-kindergarten and nursery	274	277	50,0	52,3	87	90
school-kindergarten	10	10	1,6	1,7	56	62
Rural	998	1026	62,3	64,3	65	66
including:						
kindergarten	479	458	26,0	24,6	61	65
nursery-kindergarten and nursery	504	550	35,8	39,2	67	67
school-kindergarten	15	18	0,5	0,5	70	75

The preschool education infrastructure, expressed in number of institutions, is growing. In 2007, 1334 institutions were active in the country, 29 more than in 2006. However, the increase of institutions' number does not correspond with the increase in the number of children. If we calculate the number of children, amounting to one institution, it is growing continually. In 2006, 89 children amounted to one institution, while in 2007, it reached 90 children.

By type of institution, the most popular are crèches and crèche-kindergartens, with 110,8 children per institution, the smallest rate being in the case of kindergartens – 55,1 children per institution. This fact, however, seems to be such due to the major discrepancy between areas of residence. In 2007, 55,8 thousand children amounted to 308 kindergartens in the urban area, which means over 181 children per kindergarten, while in rural areas this ratio was almost three times smaller (62,7 children per kindergarten). At the same time, we remind that crèches and crèche-kindergartens in the urban areas include a much higher percentage of children than those in rural areas.

7.9. Preschool institutions, by location

	Preschool institutions		Children, thousand		Number of children per 100 places	
	2006	2007	2006	2007	2006	2007
Total	1305	1334	116,2	120,1	73	75
Mun. Chisinau	148	148	27,4	28,7	85	89
North	420	428	30,4	31,2	72	74
Mun. Balti	35	35	5,6	5,8	92	96
Briceni	34	34	2,1	2,1	55	55
Donduseni	21	21	1,0	1,0	61	58
Drochia	38	40	2,8	2,9	67	70
Edinet	42	43	2,7	2,8	66	66
Falesti	46	47	3,2	3,3	86	87
Floresti	31	31	2,3	2,4	73	88
Glodeni	30	29	2,0	2,0	68	70
Ocnita	15	15	0,9	0,9	56	60
Riscani	38	40	2,1	2,2	68	69
Singerei	39	41	2,9	3,0	71	71
Soroca	51	52	2,8	2,8	70	73
Centre	414	431	32,7	33,8	70	72
Anenii Noi	36	36	2,8	2,9	72	73
Calarasi	28	30	1,8	1,9	49	49
Criuleni	29	29	2,6	2,6	77	77
Dubasari	11	11	1,0	0,9	69	75
Hincesti	53	53	3,9	4,0	56	56
Ialoveni	28	29	3,2	3,4	90	96
Nisporeni	22	24	1,7	1,8	69	68
Orhei	48	55	3,6	4,1	70	74
Rezina	27	29	1,5	1,6	80	85
Straseni	32	32	3,0	2,9	65	64
Soldanesti	27	29	1,3	1,3	78	89
Telenesti	34	34	2,5	2,4	74	75
Ungheni	39	40	3,8	4,0	83	90
South	265	268	19,5	19,9	62	63
Basarabasca	12	12	1,1	1,1	73	75
Cahul	54	54	5,1	5,1	65	62
Cantemir	50	50	2,8	2,9	67	68
Causeni	28	30	2,5	2,7	63	63
Cimislia	31	31	1,7	1,7	55	64
Leova	36	36	2,0	2,0	47	49
Stefan Voda	30	31	2,7	2,8	75	73
Taraclia	24	24	1,6	1,6	56	57
ATU Gagauzia	58	59	6,2	6,5	88	88

The growing number of preschool institutions in 2007, compared to 2006, happened mainly on the account of the districts in the centre (16 more institutions) and the north of the country (8 more institutions), than the districts in the south of the country, where in 2007, only 3 new institutions were opened, compared to 2006. At the same time, the ratio between the number of children and number of institutions is not very different between the areas, varying between 73 children per institution in the northern region and 78 – in the centre, incomparable with 194 children per institution in Chisinau municipality, or 166 in Balti municipality.

PRIMARY AND GENERAL SECONDARY EDUCATION

7.10. Students in day schools, gymnasiums and lyceums, by grade

thousand persons

	2006				2007			
	Urban		Rural		Urban		Rural	
	W	M	W	M	W	M	W	M
Total	100,9	97,8	144,8	148,0	95,0	91,8	135,5	138,7
including:								
preparatory	0,3	0,3	0,8	0,9	0,2	0,3	0,8	0,9
grades 1-4	27,7	29,6	50,2	53,1	26,6	28,3	46,7	50,2
grades 5-9	46,2	48,0	78,0	82,0	42,7	44,7	74,5	77,7
grades 10-11(12)	26,7	19,9	15,8	12,0	25,5	18,5	13,5	9,9

Regarding the enrolment in primary and general secondary education, we attest tendencies, which are similar to those in the preschool education. First of all, we note that gender differences are not very visible. Moreover, among students, the share of girls is larger than in the total number of children in the age groups corresponding to each cycle, which indicates the fact that boys are more exposed to the risk of not being included in education. Even more so, data point to the fact that in the cycle of entering the primary education system (preparatory classes) there is an under-representation of girls (girls constitute 45,5% of the preparatory grades' pupils and 48,6% of children at age 6). And in the cycle of exiting the primary and general secondary education system (grades 10–11/12) the situation is reversed, boys rather stay outside, accounting for 50,8% of children aged 16-18 and only 42,1% of secondary schools and lyceums students. This is due to the fact that boys, as we have mentioned before, prefer the vocational secondary education.

7.11. Students in day schools, gymnasiums, lyceums, by age group

thousand persons

	2006				2007			
	Urban		Rural		Urban		Rural	
	W	M	W	M	W	M	W	M
Total	100,9	97,8	144,8	147,9	95,0	91,8	135,5	138,7
including:								
under 7 years	1,3	1,1	2,1	1,9	1,2	1,1	2,0	2,0
7-10 years	26,6	28,2	48,1	50,4	25,9	27,2	45,2	48,1
11-15 years	45,9	47,5	77,7	81,6	42,3	43,9	73,6	76,7
16 and over	27,1	21,0	16,9	14,0	25,6	19,6	14,7	11,9

One should note the tendency that girls more often than boys are enrolled in primary education before age 7. In 2007, out of 6,3 thousand students under 7 years, 3,2 thousand were girls, so more than half, on the one hand, and on the other hand we remember that the number of girls in young age groups is smaller than boys, meaning that the percentage gap is even higher.

7.12. Graduates of day schools, gymnasiums, lyceums

thousand persons

	2006				2007			
	Urban		Rural		Urban		Rural	
	W	M	W	M	W	M	W	M
Total	19,9	17,8	21,9	21,1	19,3	17,0	20,9	20,5
gymnasiums	10,9	10,8	16,0	16,5	10,1	10,1	15,2	16,1
general secondary schools, lyceums	8,9	7,0	5,9	4,6	9,2	6,9	5,7	4,4

The number of pre-university education institution graduates is falling. The total number of graduates in 2007 was 77,7 thousand persons, 3 thousand less than in 2006. This decrease is due to demographic fall in the population of respective ages, thus, the decreasing trend is the same for gender groups or area of residences.

7.13. Teaching staff in day schools, gymnasiums, lyceums

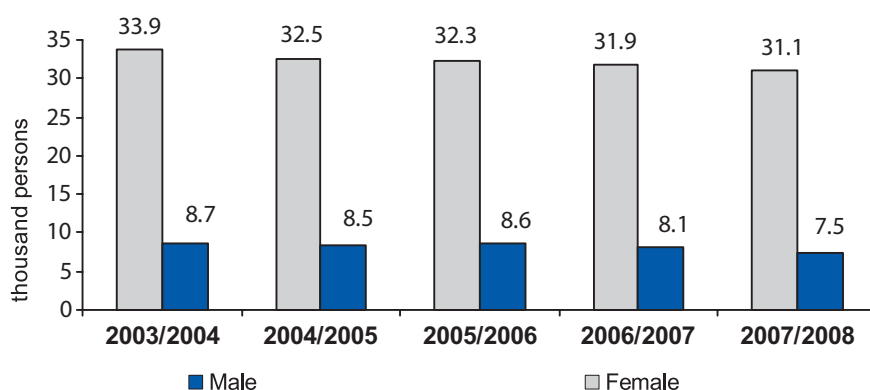

The tendency of decrease continues to be registered in the number of teaching staff, which despite changing parameters every year (ex. by education year 2004/05, the number of teaching staff had reduced by 1,6 thousand compared to the previous year, and in the following year it dropped only by 0,1 thousand, followed by another strong fall by 0,9 thousand in 2006/07 and 1,4 thousand in 2007/08), still remains constant.

Comparing gender groups, we find that the tendency of decrease is characteristic for both gender groups, except that it had different evolution. Still, if we relate the number of staff by sex to the limits of intervals provided in the chart, we conclude that in case of men the decrease is stronger. From 2003/04 till 2007/08, the number of male teaching staff has fallen by almost 14% (from 8,7 thousand down to 7,5 thousand), while the number of female teaching staff has shown just an 8% decrease (from 33,9 thousand down to 31,1 thousand).

Another finding would be that the tendency of „feminization” of education, as a labour market, remains constant, women constituting 80% of the teaching staff, percentage that has not changed too much in time.

VOCATIONAL SECONDARY AND SPECIALISED SECONDARY EDUCATION

7.14. Graduates, enrolled, and number of students in vocational secondary institutions, by sex

thousand persons

	2006/2007		2007/2008	
	W	M	W	M
Total - graduates	5,2	9,3	4,5	8,4
Apprenticeship schools	1,4	2,2	0,9	2,0
Vocational schools	3,8	7,1	3,0	5,9
Vocational lyceums	-	-	0,6	0,5
Total - enrolled	5,6	9,9	5,7	10,5
Apprenticeship schools	1,4	2,3	1,0	2,2
Vocational schools	4,2	7,6	4,1	7,7
Vocational lyceums	-	-	0,6	0,6
Total - students	8,4	15,3	8,4	16,1
Apprenticeship schools	1,6	2,4	1,1	2,2
Vocational schools	6,8	12,9	6,5	12,8
Vocational lyceums	-	-	0,8	1,1

The vocational secondary education is a cycle, preferred mainly by boys, who constituted 65% of 2007 graduates and enrolled students, and 66% of the total number of students. At the same time, there is a gender difference by type of institution, indicating the tendency of girls towards the higher level of education. The maximum share of boys is found among students of apprenticeship schools, followed by vocational schools, and the smallest share of boys, compared to the above, is in the vocational lyceums. Girls represent more than half of vocational lyceum graduates, half of enrolled students and 42% of the total number of students of such institutions.

7.15. Students of vocational secondary education, by age and sex

thousand persons

	2006/2007		2007/2008	
	W	M	W	M
Total - students	8,4	15,3	8,4	16,1
of which by age, years:				
under 16	3,1	5,7	3,3	6,4
17	2,3	4,1	2,2	4,6
18	1,8	2,7	1,8	2,9
19	0,7	1,2	0,6	0,8
20	0,2	0,5	0,2	0,3
21 and more	0,3	1,1	0,3	1,1

With respect to age, there are no major differences, except that in case of girls, compared to boys, the share of generations aged 18 and 19 is higher, which is determined by girls' main orientation towards vocational lyceums, rather than vocational and apprenticeship schools, where students are enrolled at a younger age.

7.16. Teaching staff in vocational secondary education institutions, by sex

thousand persons

	2006/2007		2007/2008	
	W	M	W	M
Total – basic staff	1,3	1,2	1,2	1,2
Apprenticeship schools	0,2	0,2	0,1	0,2
Vocational schools	1,1	1,0	1,0	1,0
Vocational lyceums	-	-	0,1	0,0

Surprisingly though, „masculinization” of vocational secondary education can be found among teaching staff, as well. Though vocational secondary teaching staff is evenly distributed by sex (1,2 thousand women and 1,2 thousand men in 2007), the share of men is much higher, than their overall share in education (37,3 thousand women and only 12,1 thousand men in education year 2007/08). Moreover, there is a correlation between the share of girls among students and the percentage of women teaching staff. In apprenticeship and vocational schools, where there is the lowest percentage of girls among students (33,3% and 33,7%, respectively), the share of women teaching staff is also smaller (33,3% and 50%) compared to vocational lyceums, where girls constitute 42,1% of the total number of students and all teaching staff are women.

7.17. Teaching staff ratio in vocational secondary institutions, by sex, during education years 2003/2004 - 2007/2008

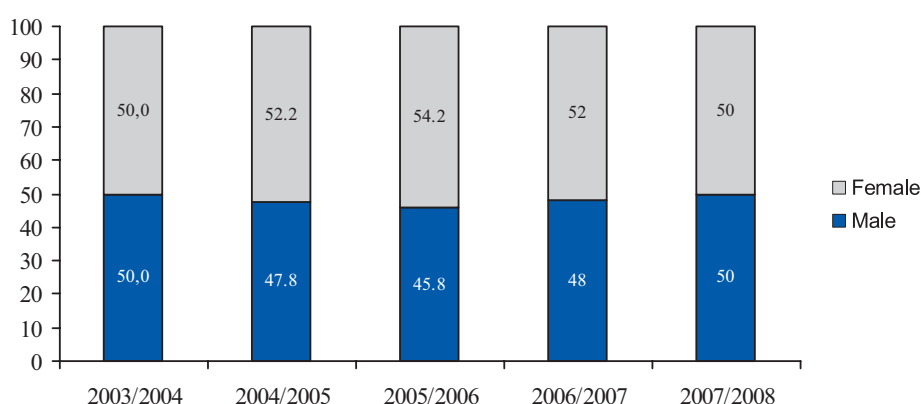

Across years, there were no major changes in the gender structure of teaching staff in vocational secondary education. The largest share of women teaching staff was registered in the education years 2004/05 and 2005/06, when teaching staff distributed by sex exactly in halves.

7.18. Graduates, enrolled, and number of students in colleges, by sex

Thousand persons

	2006/2007		2007/2008	
	W	M	W	M
Graduates	2,1	1,7	3,5	2,9
Enrolled	5,6	4,3	5,5	4,6
Students	17,0	13,2	17,6	13,7

Unlike in vocational secondary education and training, in colleges there are more girls than boys. During education year 2007/08, the college students in the country comprised 17,6 thousand girls and 13,7 thousand boys. Compared with the previous school year, the number of college students increased by 1000 students, meaning a 3,6% increase.

7.19. Students in colleges, by branch group and sex

thousand persons

	2006/2007		2007/2008	
	W	M	W	M
Total - students	17,0	13,2	17,6	13,7
of which, by sector:				
Industry	2,5	2,6	2,5	2,9
Construction	0,4	1,4	0,5	1,6
Transport	0,2	2,3	0,2	2,4
Agriculture	0,7	1,3	0,7	1,4
Economy	2,3	1,2	2,6	1,2
Law	1,2	1,4	1,0	1,1
Health care	4,2	0,8	4,4	0,9
Education	3,4	0,8	3,5	0,8
Arts and cinema	0,6	0,5	0,5	0,5
Other ¹	1,5	0,9	1,7	0,9

¹Including general institutions

7.20. Proportion of students in colleges, by branch group and sex, in education year 2007/2008

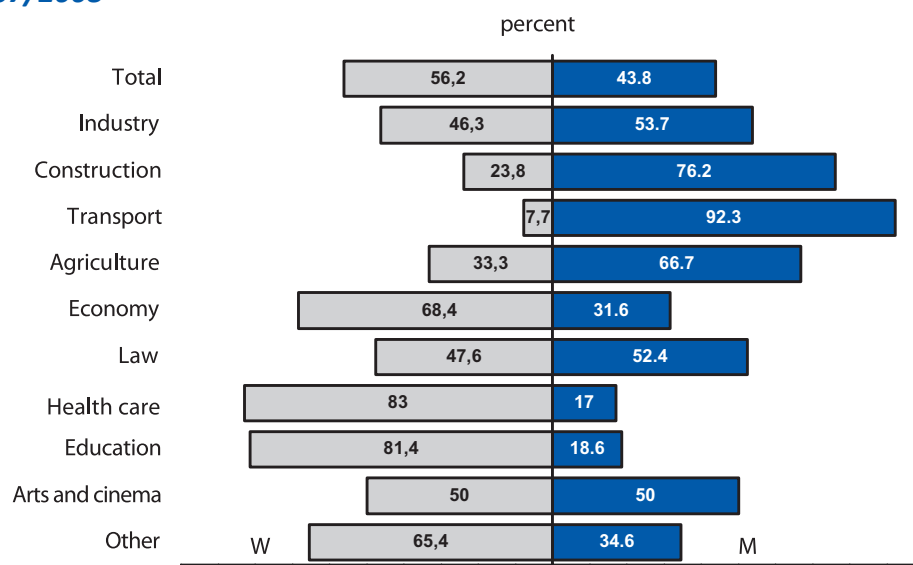

Distribution of students by sex varies, however, significantly from one branch group to another, which indicates that „masculinization” and „feminization” of some areas of economy is taking place already in the educational institutions. Such sectors as health care (83,0% girls), or education (81,4%) are fields, where women constitute the majority of employed staff. And the reverse situation is found in such sectors as constructions, transport and agriculture that are strongly „masculinized”, both in terms of labour market and education.

Age discrepancy between female and male students is minimal, so practically inexistent.

7.21. Students in colleges, by age and sex

thousand persons

	2006/2007		2007/2008	
	W	M	W	M
Total - students	17,0	13,2	17,6	13,7
of which at age, years:				
under 16	3,9	3,1	4,0	3,1
17	3,6	2,5	3,7	3,0
18	3,8	2,9	3,8	3,1
19	3,1	2,4	3,6	2,6
20	1,4	1,2	1,4	1,0
21 and more	1,2	1,1	1,1	0,9

7.22. Teaching staff in colleges, by sex, during 2003/2004 - 2007/2008 school years

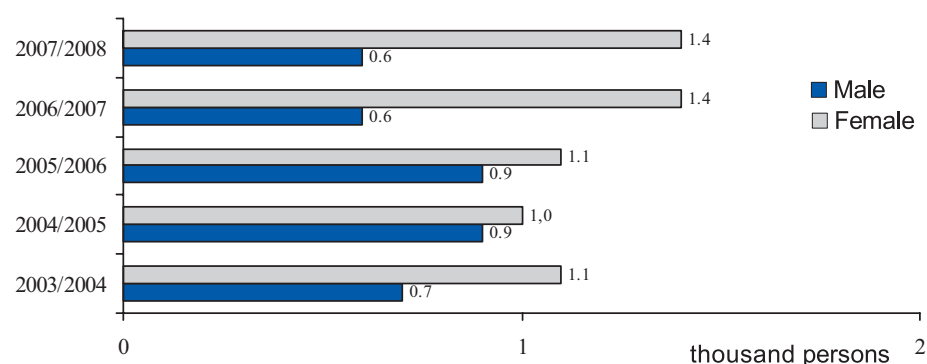

The number of college teaching staff slightly increased in 2004–2005, and remained stable (2 thousand persons) through the last three school years. At the same time, the teaching staff in colleges are predominantly women.¹⁴

¹⁴ It should be mentioned that the number of women for the last 2 years is based on estimates.

HIGHER EDUCATION

7.23. Graduates, enrolled, and number of students in higher education institutions, by sex

thousand persons

	2006/2007		2007/2008	
	W	M	W	M
Graduates	10,0	7,0	12,0	8,0
Enrolled	14,1	11,8	13,9	9,9
Students	74,2	53,8	72,4	50,5

In higher education, there is a tendency to a declining number of students. Despite that in 2007/2008, 3 thousand more students graduated from higher education institutions than in the previous year, the number of enrolments was 2,1 thousand less, and number of students decreased by 5,1 thousand.

Regarding the gender distribution among students, girls prevail (6 out of 10 students are female), and girls share in the education year 2007/08 increased to 58,9% compared to 58% in the previous year.

7.24. Graduates, enrolled, and number of students in higher education institutions, by type of education and sex

thousand persons

	2006/2007		2007/2008	
	W	M	W	M
Full-time education				
Graduates	6,9	4,6	8,1	5,2
Enrolled	11,2	9,4	11,4	8,4
Students	48,1	33,1	47,5	32,0
Part-time education				
Graduates	3,1	2,4	3,9	2,8
Enrolled	2,9	2,4	2,5	1,5
Students	26,1	20,7	24,9	18,5

The tendency of falling number of students is occurring both in full-time and part-time education. Statistics indicate the absence of any major discrepancy that would show that students of a certain sex have preference for a certain type of education, except the increase in the share of girls, who chose to be enrolled in part-time education in 2007/2008 (62,5%), while their share in 2006/2007 was 54,7%.

7.25. Students in higher education institutions, by branch group and sex

thousand persons

	2006/2007		2007/2008	
	W	M	W	M
Total - students	74,2	53,8	72,4	50,5
of which, by branch groups:				
Industry	7,0	14,0	7,0	12,9
Agriculture	4,2	5,1	4,0	4,9
Economy	13,1	8,2	13,0	7,8
Law	1,8	3,0	1,9	2,5
Health care	2,5	1,1	2,7	1,2
Physical culture and Sports	0,3	1,5	0,4	1,6
Education	36,6	14,8	35,3	13,5
Arts and cinema	0,9	0,6	0,8	0,5
Other ¹	7,8	5,5	7,3	5,6

¹Including general institutions

The students' declining number is not characteristic for all branch groups. In comparison with the education year 2006/07, in 2007/08 there was an 8% increase in the number of students in health care, and 11% increase – in physical culture and sports. The biggest reduction of students' numbers was found in such areas as arts and cinema (by 13%) and law (by 8%).

7.26. Proportion of students in higher education institutions, by branch group and sex in 2007/2008

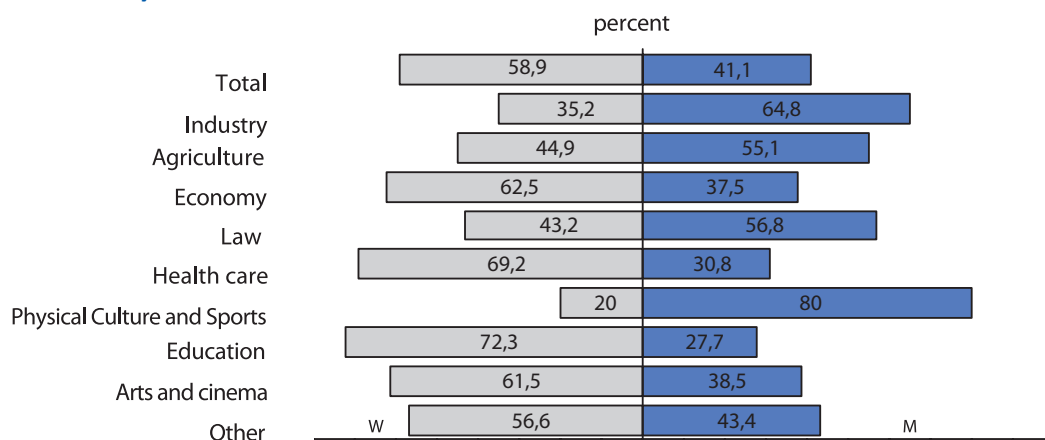

Within higher education as well, there is gender segregation by field, as noted earlier among college students. The „feminized” areas are education (72,3% girls in the total number of students), health care (69,2%), economy (62,5%) and arts and cinematography (61,5%). The fields with numerical prevalence of male students are physical culture and sports (80,0%), industry (64,8%), law (56,8%) and agriculture (55,1%). This segregation is also true for the labour market, thus producing a cycling evolution.

7.27. Students in higher education institutions, by age and sex

thousand persons

	2006/2007		2007/2008	
	W	M	W	M
Total - students	74,2	53,8	72,4	50,5
of which at age, years:				
under 18	7,8	5,8	5,8	4,6
19	11,4	9,2	11,1	7,2
20	13,6	9,1	12,4	8,6
21	12,2	8,3	13,1	8,2
22	8,5	6,3	9,6	6,9
23 and more	20,7	15,1	20,4	15,0

Data indicate almost identical age characteristics for both male and female students.

7.28. Scientific research and teaching staff in higher education institutions

thousand persons

	2006/2007		2007/2008	
	W	M	W	M
Total – basic staff	3,6	3,0	3,5	2,9
of which:				
Full-time	3,1	2,6	3,0	2,5
Part-time	0,5	0,4	0,5	0,4
from total number, with scientific degree:				
doctor of sciences	0,9	1,4	1,0	1,3
doctor habilitat	0,1	0,3	0,1	0,3

Regarding the teaching staff, two main conclusions can be outlined. On the one hand, along with the decrease in the number of students, teaching staff number also reduces. In 2007/08, the teaching and scientific staff of higher education institutions was 6,4 thousand persons, compared to 6,6 thousand in the previous year. On the other hand, women constitute 3,5 thousand persons of teaching staff that is almost 55% of the total number of staff.

Most of the teaching staff (core staff) has full-time employment, and there are no gender discrepancies in this regard, except those relating to the total number of staff.

Major discrepancies are found in the case of teaching staff distribution by scientific degree. Data prove that in the education year 2007/08, 42% of higher education staff held the doctor of science or doctor habilitat degree (2,7 thousand out of the total 6,4 thousand). At the same time, the share of women with scientific degree represents 31% versus 55% held by men.

7.29. Proportion of teaching-scientific personnel in higher education institutions, by sex, in education years 2003/2004- 2007/2008

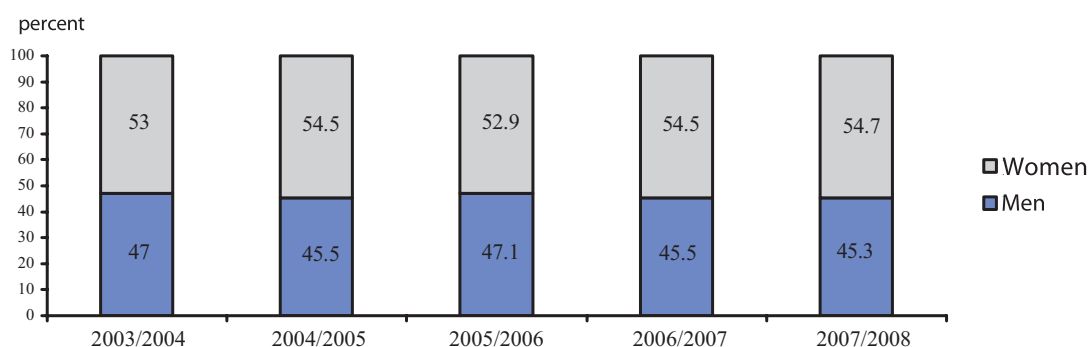

Though we have noted, that there has been a decline in the teaching staff number, the gender distribution has not shown any major changes, at least through the last 5 education years. The biggest percent of male teachers was registered in 2005/06 (47,1%), followed by a period when their share reduced to 45,3% in 2007/08.

DOCTORATE AND POST-DOCTORATE

7.30. Post-graduate education (doctoral students)

	2006		2007	
	W	M	W	M
Graduates	217	144	225	141
Enrolled	257	189	274	154
Doctoral students	959	726	1010	600

Gender distribution of doctorates raises questions. Earlier, we noted that the share of men teaching staff with doctor scientific degree is much higher than the share of women. At the same time, we see that women, to a greater extent than men, enter post-graduate doctorate education. In 2007, women prevailed among graduates of doctorate education cycle (61%), among the enrolled (64%), and among doctoral students (63%).

7.31. Doctoral students, by age and sex

persons

	2006		2007	
	W	M	W	M
Total – doctoral students	959	726	1010	600
of which, at age, years:				
under 25	249	231	219	120
26-30	483	326	504	305
31-34	123	79	160	86
35-39	53	50	56	44
40-49	45	35	63	39
50 and more	6	5	8	6

The majority of doctoral students of both sexes are aged between 26 and 30 (every second doctoral student), and every fifth one is under age 25. The age structure of women doctoral students does not differ much from the men's doctoral students' age structure.

7.32. Post-doctoral student's education

persons

	2006		2007	
	W	M	W	M
Graduates	4	8	6	7
Enrolled	8	12	8	15
Post-doctoral students	13	28	17	35

Post-doctorate education is strongly masculinized. In 2007, out of 52 post-doctorates only 17 were women. The same is true for post-doctorates enrolled in the same year – only 8 out of 23, and only in case of graduates the distribution is more balanced (6 women and 7 men).

In case of post-doctorates, men's predominance is due to the larger number of men - doctors habilitat in the higher education teaching staff. With respect to doctorates and doctors of sciences, the question remains open. Why women, who constitute 63% of doctoral students, represent just 43% (1 thousand out of 2,3 thousand) of the total number of doctors of sciences, teaching at universities (without part-timers)?

7.33. Research doctors in the research and development activity (without part-timers), 2003-2007

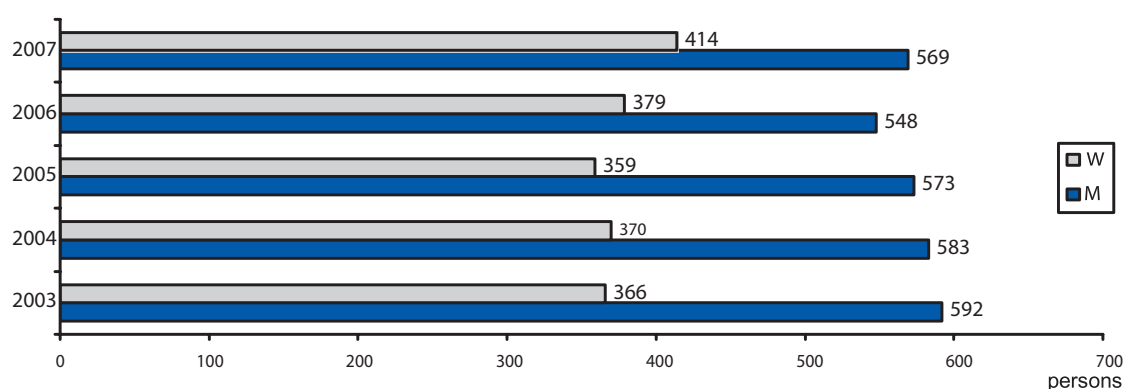

An equally „mysterious” distribution, which fails to correlate with doctorates' gender distribution, is also observed in the case of research doctors, activating in research and development. Of the total number of 983 researchers in 2007, only 414 were women (42%). Though such distribution seems to be traditional, in the last five years one may notice a slow, but constant growth of women share – from 38% in 2003 to 42% in 2007.

7.34. Research doctors habilitat in the research-development activity (without part-timers), 2003-2007

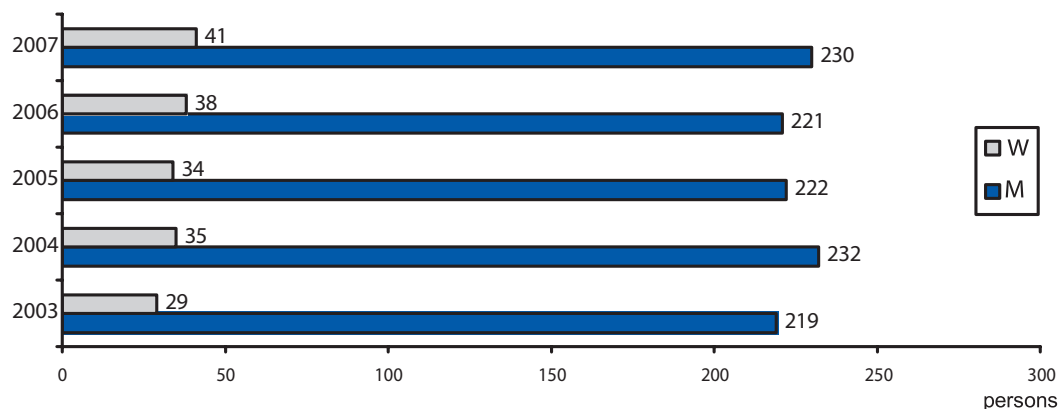

The number of doctors habilitat, involved in the research-development activity in 2007, was 217 persons, being the highest in the last five year period. Among doctors habilitat, the share of women is even lower than among post-doctorates: out of 271 doctors habilitat in 2007, only 41 were women.

On the other hand, however, as in the case of doctors of sciences, women share has been growing during the recent years, from 12% in 2003 to 15% in 2007.

The difference between the share of women among post-doctorates (33%) and doctors habilitat (15%) points to the existence of some factors, which prevent women from obtaining the degree of doctor habilitat. In this respect, there is a need for a special in-depth research to identify the factors that could explain the large gap between the share of women among doctoral students and among doctors of sciences.

8. SOCIAL PROTECTION

PENSIONS

8.1. Number of pensioners by sex and category of retirement

thousand persons

	2006			2007		
	T	W	M	T	W	M
Total pensioners	621,4	389,3	232,1	619,4	393,9	225,5
including:						
Old-age	453,8	311,7	142,1	452,3	316,8	135,5
Disability	128,3	65,6	62,7	129,7	65,8	63,9
Successors	30,2	6,4	23,8	28,7	6,2	22,5
Other categories	9,1	5,6	3,5	8,7	5,1	3,6
Share of working pensioners, %	16,6	14,7	19,8	18,8	17,3	21,4

8.2. Pensioners' share in total population, by sex, 2003-2007

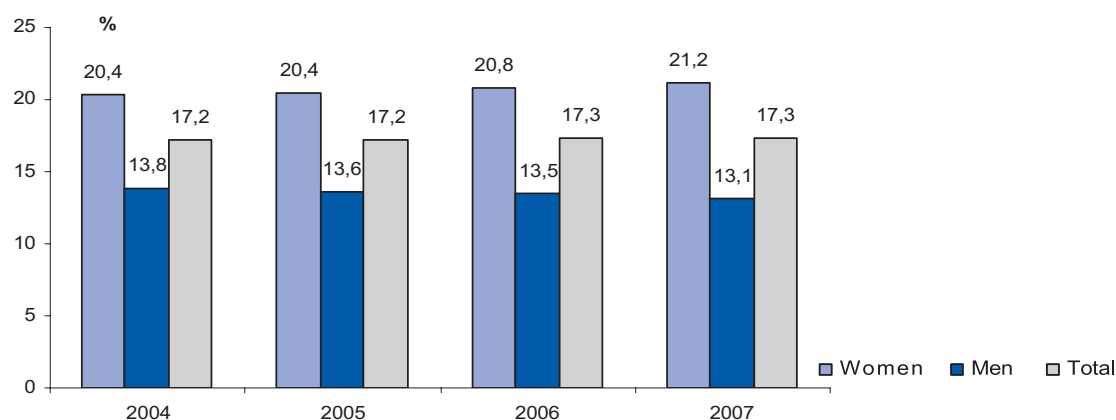

Throughout the entire period 2004-2007, more women than men entered the pensioners' category. Despite that, every year, the number of pensioners remained relatively the same (17,2%-17,3% of the total population). The share of retired women compared to men registers a slight tendency to increase (from 20,4% in 2004 to 21,2% in 2007). Also, if we look at the gender structure at pension beneficiary level, we notice that differences between shares of women and men are around 8%.

This can be explained by the fact that, as can be seen from the data produced in the Chapter „Population”, women live longer than men, their life expectancy surpassing the men's by almost 8 years.¹⁵

8.3. Number of old-age pensioners, by sex and age group

thousand persons

	2006			2007		
	T	W	M	T	W	M
Total	453,8	311,7	142,1	452,3	316,8	135,5
including by age group, years						
under 50	0,04	0,04	-	0,01	0,01	-
50-54	1,8	1,7	0,1	1,0	0,9	0,1
55-59	56,5	55,9	0,6	59,9	59,3	0,6
60-64	85,2	56,5	28,7	69,1	51,0	18,1
65 and more	310,2	197,5	112,7	322,3	205,6	116,7
Share of pensioners who get a minimum pension	6,5	6,5	6,6	6,2	6,2	6,3

¹⁵ See Table 2.7 Life expectancy at birth and at certain ages, Chapter „Population”.

Regarding the gender structure of pensioners by age group, it should be noted that women numbers are the highest in all age groups. The biggest number of pensioners is in the age group of 65 years and over, and the number of retired women in the age group 55-59 is almost equal with the number of women in the age group 55-59. Pensioners from the age group under 59 are exclusively women.

There are no notable gender differences related to the minimum pension beneficiaries, their shares for men and women being almost equal, both in 2006 and in 2007. The above data indicate that women retire a lot earlier than men, often even before the 57 years provided by the legislative system.

8.4. Number of disability pensioners, by sex and age group

thousand persons

	2006			2007		
	T	W	M	T	W	M
Total	128,3	65,6	62,7	129,7	65,8	63,9
Including by age group, years						
16-29	2,3	1,0	1,3	2,0	0,8	1,2
30-54	71,4	37,9	33,5	67,2	35,5	31,7
55-64	38,2	18,5	19,7	42,3	20,7	21,6
65 and more	16,4	8,2	8,2	18,2	8,8	9,4

8.5. Number of disability pensioners by grade of disability, cause and sex

thousand persons

	2006			2007		
	T	W	M	T	W	M
Total	128,3	65,6	62,7	129,7	65,8	63,9
including by disability grade:						
grade I	13,7	6,3	7,4	13,6	6,2	7,4
grade II	89,0	47,7	41,3	89,6	47,7	41,9
grade III	25,6	11,6	14,0	26,5	11,9	14,6
including by cause:						
common diseases	121,9	64,6	57,3	122,9	64,8	58,1
labour accident	3,7	0,9	2,8	3,6	0,9	2,7
professional disease	0,08	0,02	0,06	0,08	0,02	0,06

8.6. Share of disability pensioners in total pensioners, by sex, at 1 January 2004-2007

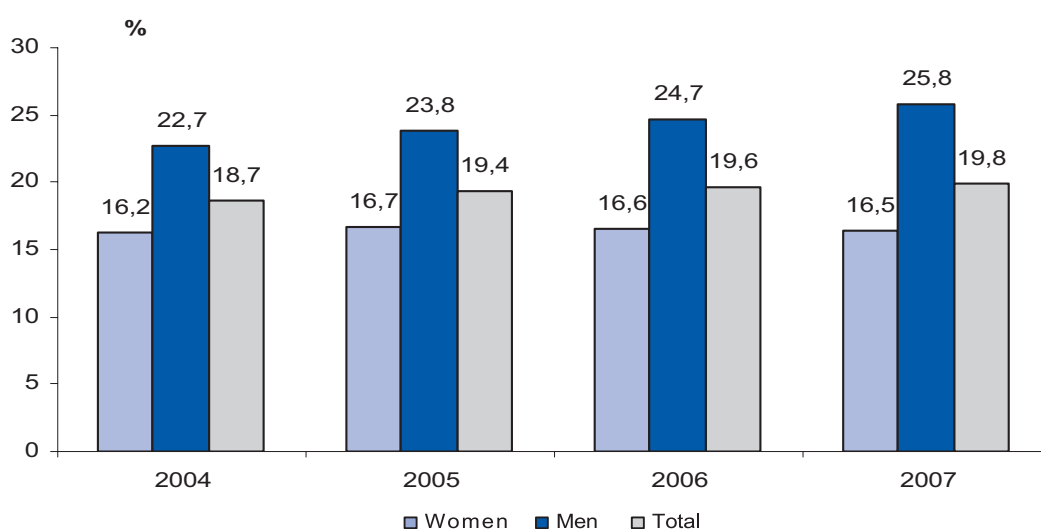

8.7. Number of disability pensioners, by age group and sex

thousand persons

	2006			2007		
	T	W	M	T	W	M
Total pensioners	119,9	63,9	56,0	122,9	64,8	58,1
including by age group, years:						
16-29	2,0	0,9	1,1	1,9	0,9	1,0
30-54	64,9	36,2	28,7	63,3	34,9	28,4
55-64	36,8	18,6	18,2	40,7	20,4	20,3
65 and more	16,2	8,2	8,0	17,0	8,6	8,4

The number of pensioners with disability registered a slight increase in 2007, compared to 2006, the number of women in this situation slightly exceeding the number of men. If we look at the gender distribution in relation to the age group, we notice that in the age group 16-29 there are more men than women, retiring because of disability. It is interesting that for the age group 30-54, women more than men are retiring because of disability (about 4 thousand more women than men). In the other age groups, in general, more men than women retire because of it, but the difference is insignificant.

Most of the pensioners with disability receive disability grade 2, regardless of sex, but mostly women than men are found in this disability category, since there are more men than women with disability grade I and III. Depending on the disability cause, the majority obtained disability because of common disease, but this category includes more women than men. There are more men than women among those, who got disability after labour accidents, in general, by 2000 men more than women.

The cases of retirement because of disease have registered a small increase in the period 2003-2007. Men retire because of disease more often than women, their share amounting to 25,8% of all retired men. For comparison, the share of women retired because of disease, compared to all retired women is 9% smaller.

8.8. Average size of old-age pension by sex, at 1 January 2002-2007

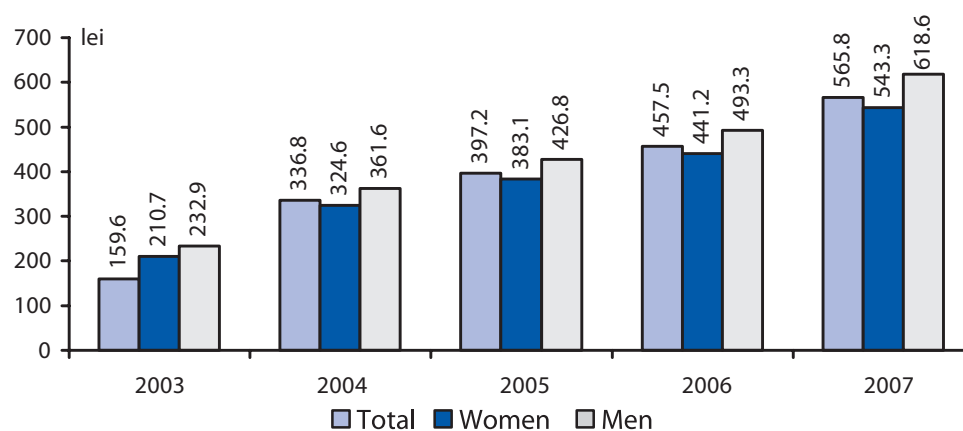

Men have a higher average old-age pension than women. Women earn on average 12% less than men. It means that the pension system is able to reduce by 20%, through re-distribution, the salary gap between men and women, which exists on the labour market, that gap constituting 32% in 2006.¹⁶

Even if for the sake of principle, we can discuss certain corrective measures, the size of the average old-age pension is still too low and in 2007 it barely reaches about 26% of the average salary in the economy.

¹⁶ See Table 6.33. Average salary in September, by economic activity, Chapter „Labour market”.

8.9. Ratio between the average old-age pension and the average salary in the economy, at 1 October, 2002-2007

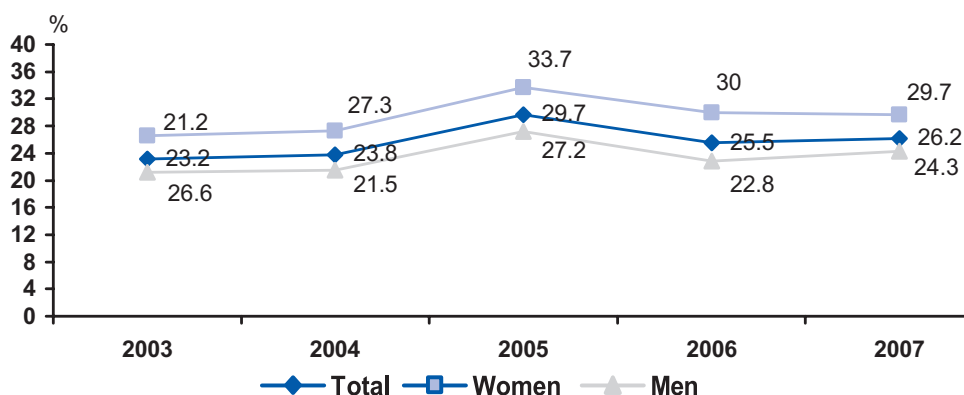

If we analyze the data on the ratio between the average old-age pension and the average salary in the economy, we can rightfully ask: though the data from Chart 3 above shows that women have a smaller pension than men, how can it be that the ratio between the women's average pension, compared with the average salary, is higher than in the case of men?

Though it seems illogical, the rate of average salary coverage from pension is higher for women, because women have a smaller salary than men, the gap between men and women average salary exceeding the difference at the level of pensions, and when women's average pension is related to women's average salary, the indicators look better than in the case of men.

Still, if we look at the Lei quantum for 2007, we notice that 29,7% of 1808,7 Lei¹⁷ (537 Lei) mean less than 24,3% of 2489,9 Lei¹⁸ (605 Lei).

8.10. Average old-age pension by sex, age group and area of residence, at 1 January

Lei

	2006				2007			
	Urban		Rural		Urban		Rural	
	W	M	W	M	W	M	W	M
Average old-age pension	485,3	573,2	416,6	451,2	604,5	728,0	508,1	561,5
Including by age group, years:								
under 50	429,6	-	336,4	-	586,7	-	394,4	-
50-54	400,3	655,6	309,9	485,6	517,9	901,8	403,7	743,1
55-59	477,7	586,1	364,7	479,1	618,3	779,3	461,8	635,1
60-64	508,2	582,6	451,0	385,0	649,6	792,4	551,9	497,3
65 and more	480,2	570,9	419,5	462,4	584,7	715,6	511,3	570,5

8.11. Number of old-age pensioners and average pensions by economic sector

	2006			2007		
	Total	W	M	Total	W	M
Total pensioners, thousand persons	453,8	311,7	142,1	452,2	316,7	135,5
including:						
farmer pension	272,7	159,1	113,6	251,9	155,2	96,7
non-farmer pension	181,1	152,6	28,5	200,3	161,5	38,8
Average old-age pension	457,5	441,2	493,3	565,8	543,3	618,6
including:						
agricultural sector employees	418,2	409,9	429,8	509,6	497,3	529,2
non-agricultural sector employees	516,8	473,9	746,2	636,6	587,4	841,6

¹⁷ Average salary of women in September 2007 (see Table 6.33. Chapter "Labour Market")

¹⁸ Average salary of men in September 2007 (see Table 6.33. Chapter "Labour Market")

The differences between the urban and rural areas are maintained in the case of pensions, as well, in disadvantage of rural areas, at all age groups levels, with marked discrepancies between women and men: in the age groups 50-54 and 55-59, rural women have a smaller pension than the urban women, who in turn, get a smaller pension, than rural men (men of urban areas get larger pensions, than rural men). Though pensioners coming from the agricultural sector form the majority of all pensioners, the average farmer's pension is smaller than that of the non-farmer's pension.

8.12. Share of pension expenditure in the GDP

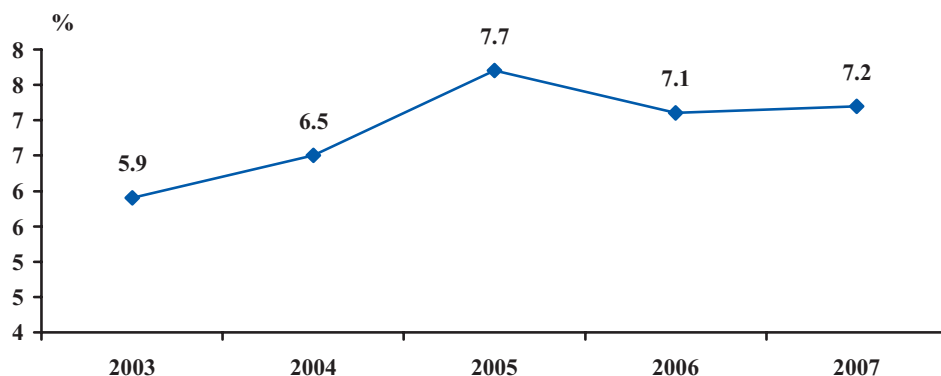

An analysis of the above data shows that women retire earlier, than men, often even before the 57 years stipulated by law. Also, as we have seen, women live longer than men and marry older men than themselves. This means that women exit the labour market earlier, earn less for a longer time (average pension covers less than 30% of the average salary) and live longer, but in very poor life quality conditions. More women than men survive their spouses and thus, the family income reduces. Therefore, for women there is a significantly higher risk of poverty at old age, than for men. The risk of severe poverty is even higher for elderly women from rural areas.

Case study – Gender-related impact of pension reform

Romania has recently passed through a pension system reform, partially privatizing the public pension system. This means that a larger and larger share of the contribution paid by the employee to the public pension fund starts being transferred to a private pension fund.

Apparently, the legislative regulations of private pensions plans are the same for men and women, but at closer view, one may notice discrepancies between levels of pensions:

Studies conducted on different states, which have reformed their pension systems, indicate differences that are generally disadvantaging women:

- In general, women register lower rates of participation in the labour market, spending more time on domestic chores – women work in paid employment system, on average, only half of the years worked by men; that is also because of interruptions due to maternity leaves and time spend on child care;
- Lower salaries, due to lower valuation of women' work and their engagement in low income economic fields – before adult age women earn on average 2/3 of what is earned by men;
- If pensions level depend on the contributions, and contributions depend on the salary, type of work and number of worked years, women get less than men;
- Women carry out family responsibilities (raising and looking after children and elderly), which determines interruptions in their employment work;

Demographic issues and the regulations related to anticipated retirement amplify discrepancies:

- Women live on average 3-5 years longer than men

and are younger than their spouses/partners, so in very many cases they survive the latter;

- Women are often allowed to retire 5 years earlier than men . It is tempting, but still this means that they accumulate less reserves for the retirement period;
- If we add to this the fact that they live longer than their spouses/partners, the risk of poverty is even higher – since they live a longer time with less reserved resources.

The role of life expectancy is important in establishing the pension benefits for men and women, in conformity with the private pension system, because the cost of annuity is calculated based on the life expectancy (the financial mechanism of monthly payment of pension). If the system copies the private insurance practices of using different tables for men and women life expectancy, then women may receive just half of what men get *

For Romania, the estimations made in connection with the gender impact of the pension reform indicate that the smaller number of worked years, lower earnings and longer life expectancy can result in a reduction of the average pension of women by about 34% in comparison with the public system pension, if the situation remains unchanged **.

*According to simulations made for Poland, within the study „Gender dimension of pension reform in Central and Eastern Europe: Cases of Czech Republic, Poland and Hungary”, conducted by ILO-CEET.

**The report „Gender Dimension of social security system reform in Romania”, coordinated by Marian Preda, financed by ILO-CEET.

8.13. Number of persons contributing to the social security system

thousand persons

	2006			2007		
	T	W	M	T	W	M
Total persons	1083,2	555,7	527,5	1185,2	603,9	581,3
including by age group, years:						
under 35	354,6	183,8	170,8	388,0	199,3	188,7
35-45	230,0	124,7	105,3	242,2	130,0	112,2
45-55	290,5	152,7	137,8	309,9	162,0	147,9
55-60	116,4	57,7	58,7	136,2	68,2	68,0
60 and over	91,7	36,8	54,9	108,9	44,4	64,5
Share of people contributing to the social security system in the total economically active population	79,8	83,3	76,4	90,2	92,8	87,7

The economically active population of the Republic of Moldova, which contributes to the system of social security is growing with 10%, from 79,8% in 2006 to 90,2% in 2007. Women contribute more to public budget compared to men, the percentage of women is higher than the percentage of men, for both years: almost 7 % more women than men contributed to the social security system in 2006, and 5% more in 2007.

It is curious to notice that, considering gender distribution, among the contributors to the social security system, by age group, there are more women than men, except for persons of 60 years and over, where the situation is opposite. This is explained by the fact that more women, than men from this age group, retire earlier and their contribution to the system stops.

Also, it is notable that the gender gap is more obvious with regard to the contributions in the age group 35-45 years.

8.14. Number of persons on child care leave by sex

persons

	2006				2007			
	Urban		Rural		Urban		Rural	
	W	M	W	M	W	M	W	M
Persons on child care leave	27636	179	79374	3022	27852	172	75312	3206
including by category:								
Insured persons	11860	49	13363	122	12663	50	13685	108
of which:								
monthly allowance for child care up to the age of 3 years	11623	40	11621	25	12444	47	12330	31
monthly allowance for a child aged 3-16 years	237	9	1742	97	219	3	1355	77
Uninsured persons	15776	130	66011	2900	15189	122	61627	3098
of which:								
monthly allowance for child care up to the age of 3 years	10806	34	26342	88	10994	22	26829	75
monthly allowance for a child aged 3-16 years	4970	96	39669	2812	4195	100	34798	3023

8.15. Share of women on maternity leave in the total number of women of fertile age, 2004-2006

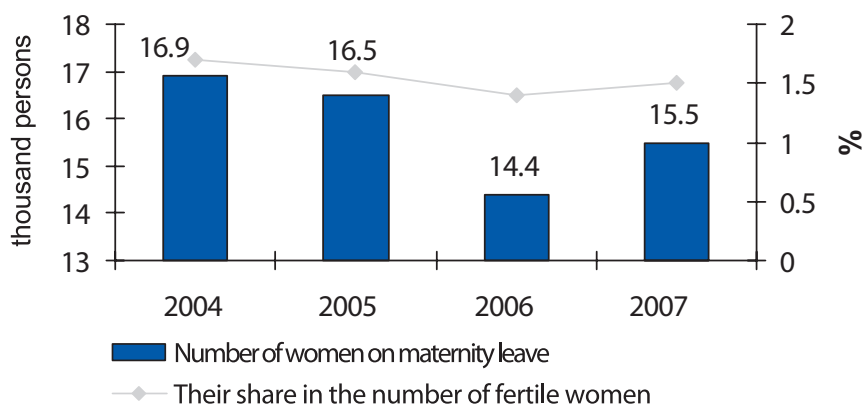

In most of the cases, women assume the traditional role of children rearing. Both in 2006 and in 2007 more than 97% of the persons in child care leave were women and little more than 2% were men. In the urban area, 99% of these persons are women and below 1% are men. In rural areas, the percentage of men in child care leave increased slightly from 3,66% to 4,1%. The persons who are not insured in the social security system have a higher presence than those insured with regard to the receipt of the monthly indemnification for child care up to 3 years, as well as for children aged 3-16 years.

Starting with 2004 and until 2007 the number of women on maternity leave decreased continuously, with a slight trend for ascendance in 2007. Only 1,5% of the women of fertile age from the Republic of Moldova were in 2007 on maternity leave. The birth rate decreasing tendency, recorded in the Republic of Moldova, feeds into the more general and prominent tendency, existent in all developed states or countries in transition.

Începînd cu anul 2004 și pînă în 2007 numărul femeilor aflate în concediu de maternitate a scăzut continuu, înregistrîndu-se totuși o oarecare revenire pe o tendință de creștere în 2007. Doar 1,5% dintre femeile de vîrstă fertilă din Republica Moldova se aflau în 2007 în concediu de maternitate. Tendință de scădere a natalității care se înregistrează în Republica Moldova se înscrie în tendința generală și mai pregnantă, existentă la nivelul tuturor statelor dezvoltate sau aflate în tranziție.

8.16. Average size of child allowances

	2003	2004	2005	2006	2007
<i>lei</i>					
<i>One-time allowance upon birth of the first child</i>					
insured persons (aged under 3 years)	420	420	500	800	1000
uninsured persons (aged under 1,5 years)	300	380	500	800	1000
<i>One-time allowance upon birth of the second and other children</i>					
insured persons (aged under 3 years)	280	280	500	800	1000
uninsured persons (aged under 1,5 years)	200	250	500	800	1000
<i>Monthly allowance for child care</i>					
insured persons (aged under 3 years)	100	100	149,9	182,8	230,8
uninsured persons (aged under 1,5 years)	75	75	100	100,0	100
<i>Monthly allowance for lone mothers with children aged 1,5-16 years</i>	25	50	50	50	50

8.17. Ratio between child allowances and subsistence minimum for children

	2006	2007
<i>percent</i>		
One-time allowance upon birth of the first child	93,9	99,7
One-time allowance upon birth of the second and other children	93,9	99,7
Monthly allowance for child care		
insured persons (aged under 3 years)	54,8	58,5
uninsured persons (aged under 1,5 years)	30,0	25,4
Monthly allowance for lone mothers with children aged 1,5-16 years	5,9	4,5

8.18. Expenditures of the state social insurance budget

million lei

	2003	2004	2005	2006	2007
Social insurance budget – total	2173,9	2768,9	3697,7	4378,1	5244,5
including: pensions	1629,9	2064,9	2897,8	3189,3	3840,6
allowances upon birth	7,8	10,2	15,4	26,9	35,3
allowances for care	59,6	96,5	128,3	157,5	161,2

The amount of the child indemnifications raised constantly from 2003 to 2007, especially the single-payment indemnifications. The monthly indemnifications did not record a similar constancy in raising, reaching in 2007 less than 20% of the average salary, in the case of insured persons.

Although it is quite praiseworthy the fact that there is a special monthly indemnification for the support of the single mothers with children from 1,5-16 years, its amount is insignificant and remained at the same level (50 leis) from 2004, regardless of the inflation.

The social security budget raised constantly from 2003 to 2007, reaching an almost doubled level. As expected, the most part is assigned to the pensions budget (more than 73% in 2007). Only little more than 3% is distributed for child care indemnifications and 0,7% for birth indemnifications.

8.19. Boarding houses for elderly and disabled

	2003	2004	2005	2006	2007
Boarding houses for elderly and disabled adults	6	6	6	6	6
including persons	2105	2108	2188	2276	2177
Boarding houses for disabled children	2	2	2	2	2
including persons	581	610	640	679	671

During 2003-2007 the number of geriatric homes for the elderly and the disabled at national level remained the same, while with each year the number of accommodated persons increased. Thus, over the last years, each institution of this type accommodated on average 360 persons. The same is true for boarding houses for disabled children, which are only 2. According to the data from 2007, such a boarding house should accommodate more than 335 persons.

8.20. Placement of children and adolescents left without parental care

persons

	2003	2004	2005	2006	2007
Total	1809	1788	2111	2303	2182
of which employed in:					
Institutions	391	389	497	695	548
of which:					
children's homes	65	75	135	207	332
orphanages	30	28	39	110	37
boarding schools for orphan children	172	153	114	168	112
general boarding schools	124	133	209	210	67
Families	1318	1293	1446	1344	1427
of which:					
under guardianship	960	933	1056	895	1024
under patronage	197	223	261	292	232
adopted	161	137	130	157	171
education institutions	50	68	79	228	147

During 2003-2007 the number of children and teenagers left without parental care, placed in institutions or families, raised slightly, but constantly, reaching the climax in 2006 with 2303 persons. The most important fact related to this is that in each year, during this period, the most part of these children were placed in families, the percentage of such children in total varying from 73% in 2003 to 66% in 2007.

9. CRIMINALITY

PERSONS WHO COMMITTED OFFENCES

9.1. Persons who committed offences

	2003		2004		2005		2006		2007	
	W	M	W	M	W	M	W	M	W	M
Total persons	1945	14653	2049	16022	2099	15779	2250	15122	1870	13431
Total minors	246	2353	242	2945	252	2360	187	1973	134	1681
Total persons per 100 000 people	104	848	109	929	112	918	121	879	101	782
Total minors per 100 000 people	52	493	53	617	58	515	45	448	32	389

In 2007 13431 men and 1870 women committed offences. From the total number of offences, 1681 were committed by male minors and 134 by female minors. It is noticeable the fact that the percentage of women in the number of minor offenders is 7,4 percent, while in the total number of offenders it is 13%, this proves that criminality as phenomenon appears amongst boys at younger ages than in case of girls.

9.2. Persons who committed offences per 100 thousand persons

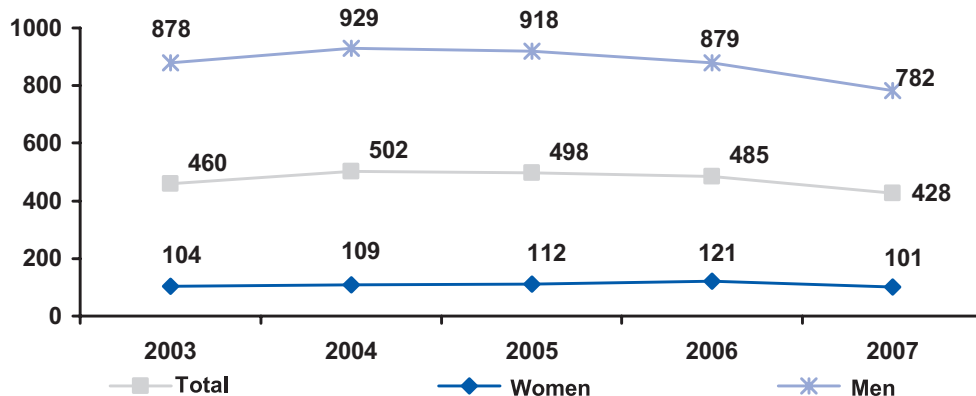

In the last five years, the criminality level remained relatively constant, with a more obvious decrease in 2007 to 428 offenders per 100 thousand persons for men and 101 respectively for women.

9.3. Minors who committed offences per 100 thousand persons

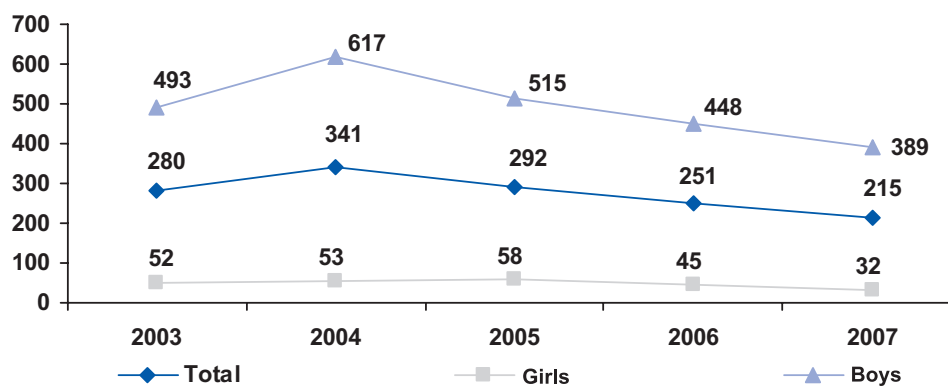

In the case of minors, the evolution of the criminality was specific, pointing out the year of 2004, when a significant and sudden rise of the criminality's level was recorded (617 minor offenders per 100 thousand persons compared to 493 in 2003). But this sudden ascending is related to the increase of the criminality's level as for boys, while in the case of girls, the evolution was constant, with a climax in 2005 (58 cases per 100 thousand persons).

After the maximum levels, reached in 2004 for boys and in 2005 for girls, the frequency of the offences went down significantly in the following years, thus in 2007 it was 389 for boys and 32 for girls.

9.4. Persons who committed offences, by main type of offences, by sex and area of residence

	2006						2007					
	Total		Urban		Rural		Total		Urban		Rural	
	W	M	W	M	W	M	W	M	W	M	W	M
Total offences	2250	15122	1409	8978	841	6144	1870	13431	1161	8032	709	5399
including:												
Murder	28	224	12	123	16	101	21	183	16	85	5	98
Malicious injury	68	912	32	384	36	528	56	1005	16	357	40	648
Rape		211		84		127	2	207	2	81		126
Theft	648	6210	356	3178	292	3032	563	5138	346	2857	217	2281
Burglary	34	860	27	664	7	196	23	744	15	574	8	170
Plunder	1	190		127	1	63	4	186	3	129	1	57
Hooliganism	19	749	11	313	8	436	27	717	14	293	13	424
Drug-related offences	361	1417	161	1199	200	218	355	1433	134	1191	221	242
Other	1091	4349	810	2906	281	1443	819	3818	615	2465	204	1353
	per 100 000 people											
Total offences	120	880	185	1266	76	608	101	780	148	1156	66	526
including:												
Murder	1	13	2	17	1	10	1	11	2	12		10
Malicious Injury	4	53	4	54	3	52	3	58	2	51	4	63
Rape		12		12		13		12		12		12
Theft	35	361	47	448	26	300	30	299	44	411	20	222
Burglary	2	50	4	94	1	19	1	43	2	83	1	17
Plunder		11		18		6		11	0	19		6
Hooliganism	1	44	1	44	1	43	1	42	2	42	1	41
Drug-Related Offences	19	82	21	169	18	22	19	83	17	171	21	24
Other	59	253	103	418	26	141	44	222	79	355	19	132

With regard to types of offences, the major share for both groups is related to thefts (nearly 38% from the total number for men and 30% for women). The crimes specific to men (who reported a higher percentage from the total, compared to women) are: voluntary infliction of injuries (in the case of men 7,5% from the total, while amongst women 3%), robberies (in the case of men 5,% from the total, amongst women 1,2%) and misconduct (in the case of men 5,3%, and amongst women 1,2%). The crimes more specific to women are those related to drugs, which form approximately 19% from the total number of the crimes committed by women and only 10,6% from the total of crimes committed by men.

9.5. Persons who committed offences per 100 thousand persons, by area of residence

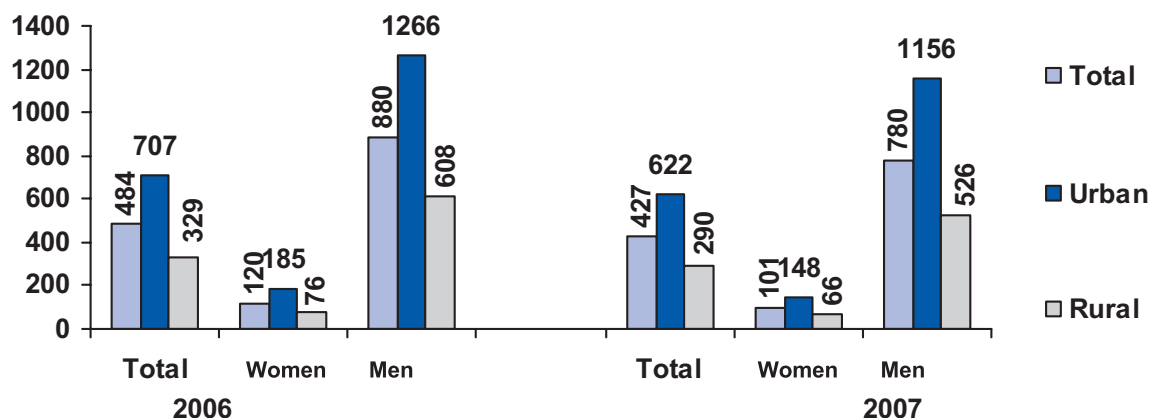

The women's criminality is lower than the men's one, regardless of the area of residence, and in the gender groups there are no major differences with regard to the frequency of the offence by area of residence. Thus, the number of offenders per 100 thousand persons from rural areas related to the same indicator from the urban area, shows a coefficient of 2,2 for both, in other words both men and women in urban areas commit 2,2 times more offences than those from rural areas.

9.6. Minors who committed offences, by main type of offences, by sex and area of residence

	2006						2007					
	Total		Urban		Rural		Total		Urban		Rural	
	W	M	W	M	W	M	W	M	W	M	W	M
Total offences	187	1973	115	1029	72	944	134	1681	91	962	43	719
including:												
murder		11		2		9		15		4		11
malicious injury	2	39	1	15	1	24	2	52	2	13		39
rape		24		7		17		28		5		23
theft	148	1389	89	675	59	714	113	1094	74	583	39	511
burglary	8	163	6	123	2	40	5	183	4	161	1	22
plunder		27		17		10		24		13		11
hooliganism		85		30		55	2	75	1	43	1	32
drug-related offences	5	73	3	62	2	11	1	42	1	38		4
other	24	162	16	98	8	64	11	168	9	102	2	66
	per 100 000 people											
Total offences	45	448	77	652	27	334	32	389	62	619	16	260
including:												
murder		3		1		3		4		3		4
malicious injury	1	9	1	10	0	9	1	12	1	8		14
rape		5		4		6		7		3		8
theft	35	315	60	428	22	253	27	253	50	375	15	185
burglary	2	37	4	78	1	14	1	42	3	104	0	8
plunder		6		11		4		6		8		4
hooliganism		19		19		20	1	17	1	28	0	12
drug-related offences	1	17	2	39	1	4	0	10	1	25		1
other	1	9	2	14	1	6	1	10	1	15	0,2	6,4

The structure of criminality amongst minors has a special character. Firstly, the share of the thefts is even higher (79% for girls and 70% for boys) compared to that of the total number of offenders. Offences more specific to men are identified (voluntary infliction of injuries, robbery, misconduct). On the other hand, offences related to drugs, which have a higher level amongst women compared to men, cannot be identified as more specific to minor girls than boys. To this type of offences is referred 2,8% from the total number of offences committed by boys in 2007, and only 0,8% from the total number of girls in the same year.

9.7. Minors who committed offences per 100 thousand minors, by area of residence

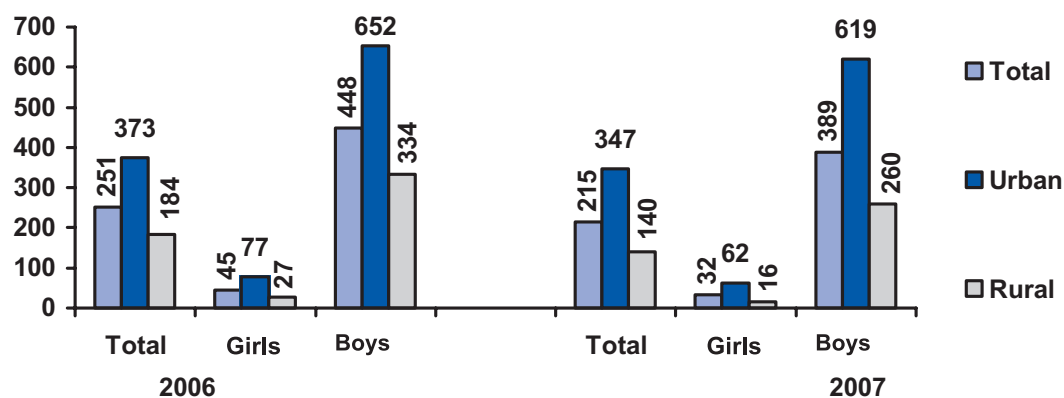

The criminality amongst minor girls is lower than amongst boys, regardless of the area of residence. At the same time, unlike criminality coefficient in general, in the case of minors, we could say that, for girls, the urban factor has a greater impact with regard to the raise of the criminality level, than for boys. Thus, the number of the offenders per 100 thousand persons from rural areas related to the same indicator from the urban area, shows that girls from the urban areas commit offences 3,8 more frequently than those from rural areas, while boys from cities only 2,4 times more frequently than those from villages.

9.8. Persons who committed offences, by age group, sex and area of residence

	2006						2007					
	Total		Urban		Rural		Total		Urban		Rural	
	W	M	W	M	W	M	W	M	W	M	W	M
Total offences	2250	15122	1409	8978	841	6144	1869	13431	1161	8032	709	5399
including:												
14-15	72	763	45	370	27	393	60	695	35	402	25	293
16-17	115	1210	70	659	45	551	74	986	56	560	18	426
18-24	480	5021	364	3031	116	1990	382	4412	283	2669	99	1743
25-29	279	2310	198	1485	81	825	195	2152	132	1415	63	737
over 30	1304	5818	732	3433	572	2385	1159	5186	655	2986	504	2200
	per 100 000 people											
Total offences	120	880	185	1266	76	608	101	780	148	1156	66	526
including:												
14-15	121	1224	200	1556	72	1020	101	1130	161	1791	66	750
16-17	168	1712	264	2416	107	1269	108	735	212	2071	46	1034
18-24	195	1997	391	3119	76	1290	159	1782	231	2316	84	1317
25-29	186	1501	332	2368	89	905	136	1461	197	2202	82	888
over 30	124	666	159	877	96	495	109	580	147	830	82	412

Thus, the criminality amongst men is wider spread at the young age, than in the case of women. Considering the percentage distribution (see charts below) by ages of the persons who committed offences in 2007, it is obvious that in all age categories up to 29 years, the percentage for men is higher than for women. For instance, from the total number of male offenders 5,2% were aged between 14 and 15 years (695 out of 13431), while amongst women who committed offences, only 3,2% were from this age group. And only for the age group of 30 years and above, 62% (1158 out of 1869) are related to it.

With regard to the area of residence, there are specific tendencies also, which show that in the urban area, criminality has a younger face. Both for women and men from cities, the share of the younger ages is higher than in rural areas, only except for the 14-15 years age group.

9.9. Women who committed offences, by age group in 2006-2007

2006

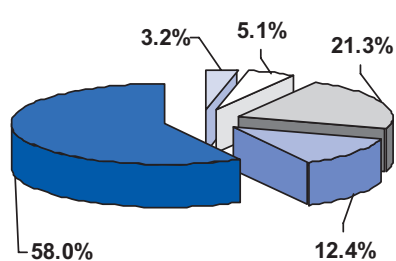

14-15 Years

16-17 Years

18-24 Years

25-29 Years

over 30 Years

2007

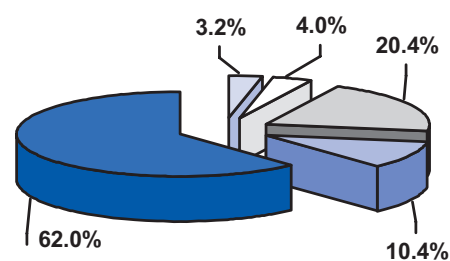

9.10. Men who committed offences, by age group in 2006-2007

2006

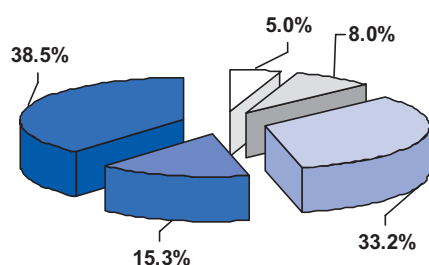

14-15 Years

16-17 Years

18-24 Years

25-29 Years

over 30 Years

2007

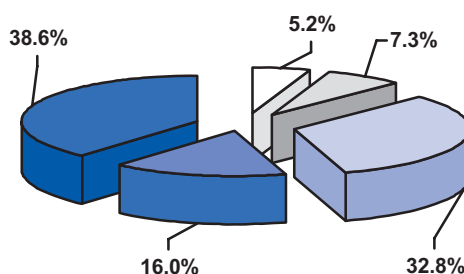

9.11. Persons who committed offences, by main type of offences, age group and area of residence

	2006						2007					
	Total		Urban		Rural		Total		Urban		Rural	
	W	M	W	M	W	M	W	M	W	M	W	M
Murder												
14-15		4				4		2				2
16-17		7		2		5		13		4		9
18-24	6	45		35	6	10	4	37	4	19		18
25-29	3	44	1	22	2	22	2	31	1	21	1	10
over 30	19	124	12	64	7	60	15	100	11	41	4	59
Burglary												
14-15	2	46	1	29	1	17	3	81	2	71	1	10
16-17	6	117	5	94	1	23	2	102	2	90		12
18-24	11	424	9	334	2	90	9	334	7	256	2	78
25-29	4	113	3	90	1	23	1	107	1	76		31
over 30	11	160	9	117	2	43	8	120	3	81	5	39
Theft												
14-15	66	625	41	301	25	324	55	532	31	288	24	244
16-17	82	764	48	374	34	390	58	562	43	295	15	267
18-24	185	2181	129	1198	56	983	169	1677	120	964	49	713
25-29	75	851	39	452	36	399	65	768	31	456	34	312
over 30	240	1789	99	853	141	936	216	1599	121	854	95	745
Plunder												
14-15		7		4		3		3				3
16-17		20		13		7		21		13		8
18-24		95		64		31	1	96		67	1	29
25-29	1	21		12	1	9		34		27		7
over 30		44		34		10	3	32	3	22		10
Hooliganism												
14-15		28		9		19		18		9		9
16-17		57		21		36	2	57	1	34	1	23
18-24	9	340	5	128	4	212	5	322	3	118	2	204
25-29	1	122	1	48		74	5	111	2	40	3	71
over 30	9	202	5	107	4	95	12	212	8	92	4	120

CONVICTED PERSONS

9.12. Convicted persons

	2004		2005		2006		2007	
	W	M	W	M	W	M	W	M
Total persons	1142	11609	1146	12957	1326	11108	1236	8528
Total minors	96	1678	118	1770	72	1244	28	634
Total persons per 100 000 people	61	672	61	751	71	646	66	496
Total minors per 100 000 people	21	352	27	386	17	282	7	147

In 2007 there were 1236 convicted women and 8528 convicted men, i.e. women represented 12.7% of the total number of convicted persons. With regard to minors, the share of girls among them was even lower – 4.2%.

9.13. Convicted persons, by type of punishments administered by courts, by area of residence of convicted person

	2006			2007		
	T	W	M	T	W	M
Total convicted persons	12434	1326	11108	9764	1236	8528
including:						
imprisonment	2932	198	2734	2261	164	2097
arrest	11	11				
fine	2281	357	1924	2313	392	1921
conditional sentence	3648	471	3177	2755	440	2315
suspension of punishment execution	30	30		13	13	
unpaid work for community benefit	3273	252	3021	2355	222	2133
other punishments	259	18	241	67	5	62
including per 100 000 people						
Total convicted persons	346	71	646	273	66	496
including:						
imprisonment	82	11	159	63	9	122
arrest	0	1				
fine	64	19	112	65	21	112
conditional sentence	102	25	185	77	24	135
suspension of punishment execution	1	2		0	1	
unpaid work for community benefit	91	13	176	66	12	124
other punishments	7	1	14	2	0	4

The distribution by type of conviction displays directly the gravity of the committed crimes, although not proportionally, there are other factors, like the fact that women benefit more frequently of a punishment mitigation, given the fact that women are more likely to take care of children. In fact, from the total number of convictions, in 2007 for women, in 13,3% of the cases, the court decided the imprisonment, while in the case of men 24,6% (see charts below). Also men, more frequently than women, are condemned to non-remunerated community works (25% men, compared to 18% for women). Women are given more frequently fines, conditional sentence or suspended sentence (in 2007 from the total number of 13 cases of punishment suspension, all 13 were given to women).

9.14. Distribution of convicted women, by punishment, 2006-2007

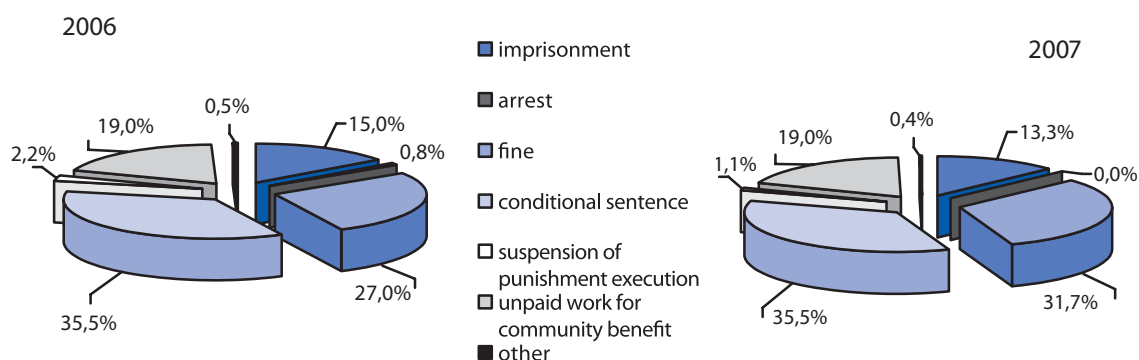

9.15. Convicted men, by punishment, 2006-2007

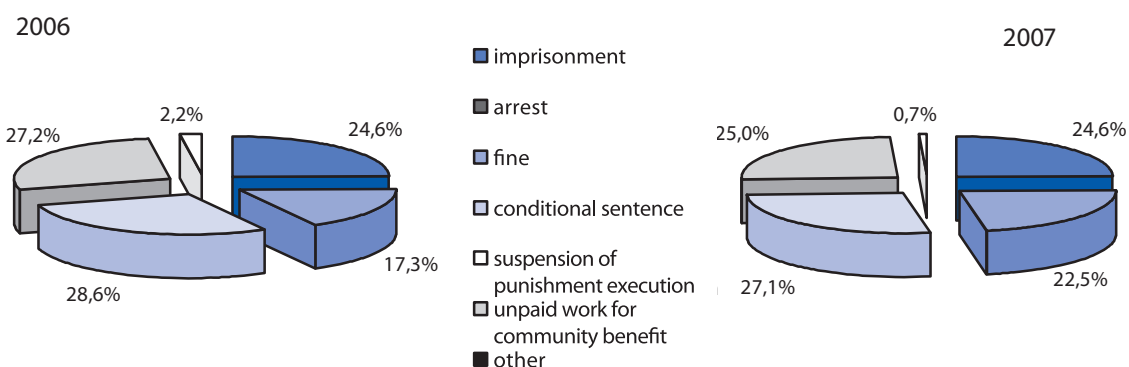

9.16. Convicted persons by type of crime

	2006			2007		
	T	W	M	T	W	M
Total convicted persons	12434	1326	11108	9764	1236	8528
including for:						
murder	279	17	262	203	16	187
malicious injury	342	31	311	350	22	328
rape	192	3	189	138	3	135
theft	4355	417	3938	2121	265	1856
burglary	742	21	721	544	27	517
plunder	211	4	207	177		177
hooliganism	660	16	644	642	20	622
drug-related offences	1268	225	1043	1452	298	1154
other	4385	592	3793	4137	585	3552
including per 100 000 people						
Total convicted persons	346	71	646	273	66	496
including for:						
murder	8	1	15	6	1	11
malicious injury	10	2	18	10	1	19
rape	5	0	11	4	0	8
theft	121	22	229	59	14	108
burglary	21	1	42	15	1	30
plunder	6	0	12	5		10
hooliganism	18	1	37	18	1	36
drug-related offences	35	12	61	41	16	67
other	122	32	220	116	32	207

In both groups, the most part of the offences followed by convictions are thefts and drug-related offences. The only difference is the fact that men are mostly convicted for offences qualified as thefts

(21,76%) whilst in the case of women drugs related offences (24,11%) have a slightly higher presence than thefts (21,44%). On the other hand, men are more frequently convicted for grave offences, such as plunder, malicious injuries and hooliganism, than women.

9.17. Distribution of convicted women, by committed offence, in 2006-2007

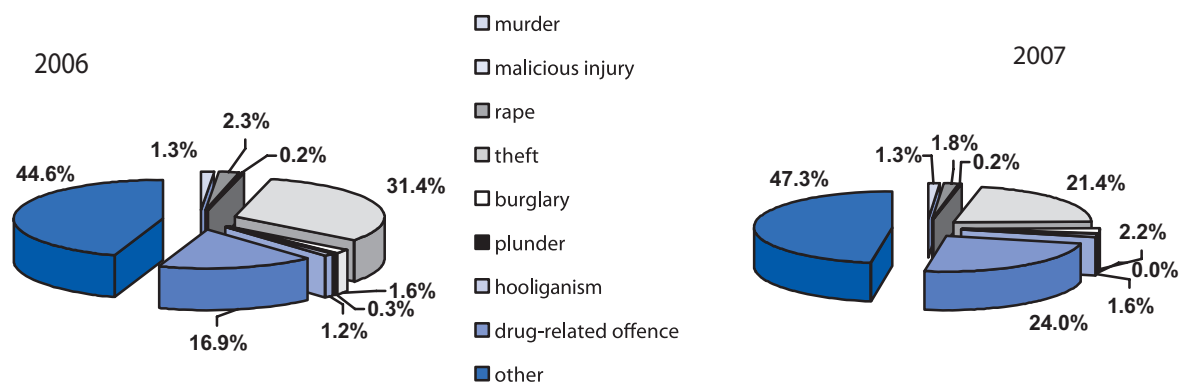

9.18. Convicted men, by committed offence, in 2006-2007

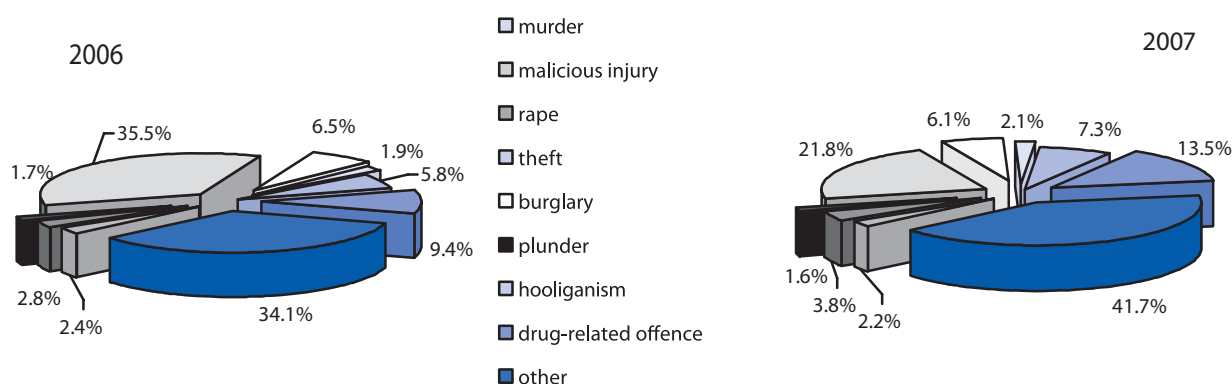

PERSONS DETAINED IN PENITENTIARIES

9.19. Number of detainees in penitentiaries

	2003	2004	2005	2006	2007
Total persons	10591	9377	8876	8679	7895
including:					
convicted persons	7836	6920	6404	6647	6521
persons in preliminary detention	2755	2457	2472	2032	1374
per 100 000 people					
Total persons	293	260	247	242	220
including:					
convicted persons	217	192	178	185	182
persons in preliminary detention	76	68	69	57	38

In the last years, the number of the detainees in the penitentiaries continuously fell down from 10591 in 2003 to 7895 in 2007. A quality change occurred especially with regard to the share of the persons in preliminary detention, compared to the total number of convicted, while in 2003 these were 26%, in 2007 they were already 17,4%.

9.20. Number of detainees in penitentiaries

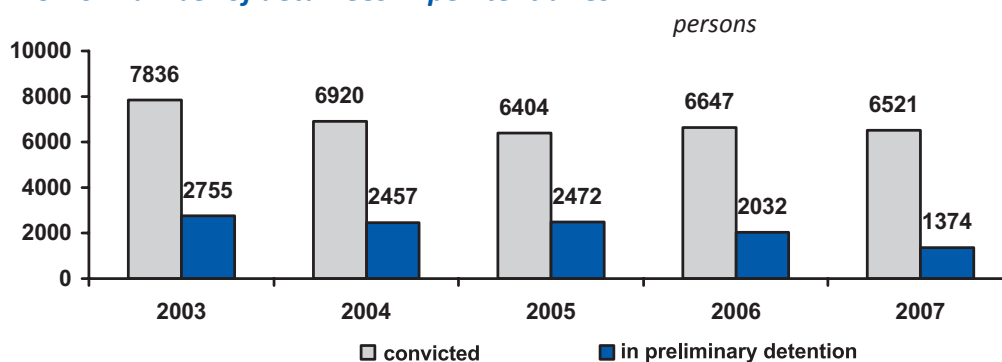

9.21. Distribution of detainees in penitentiaries per 100 thousand persons

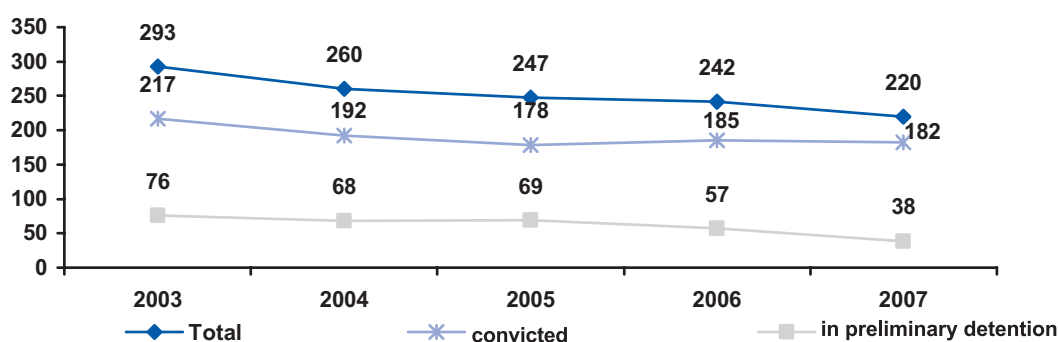

The evolution of the number of detainees, reported to 100 thousand persons, was different for convicted and for persons in preliminary detention. Although the total number of detainees constantly decreased, until 2005 this happened due to the decrease of the number of convicted persons, and from 2005 to 2007 (when the number of the convicted persons also raised) the decrease of the general number happened due to the fast reduction of the number of persons in preliminary detention.

9.22. Number of convicted persons in penitentiaries

	2003		2004		2005		2006		2007	
	W	M	W	M	W	M	W	M	W	M
Total persons	329	7507	244	6676	247	6157	312	6335	303	6218
Total minors	10	99	2	33	5	64	14	124	4	88
Total persons per 100 000 people	17	433	13	386	13	357	17	368	16	361
Total minors per 100 000 people	7	67	1	23	4	46	11	93	3	68

In 2007 a number of 6521 persons were in the service of term in penitentiaries, of which 303 were women (4,6%). The gender distribution of the detained in penitentiaries did not suffer important modifications, thus the share of the male detained in the last five years varied maximum from 96,5% in 2004 to 95,3% in 2006 (see the chart below).

With regard to the minors convicted in penitentiaries in the last five years, significant and apparently chaotic fluctuations were recorded, both in a numerical and in a gender perspective. Thus from 2003 to 2004, the number of minors reduced thrice (from 109 to 35), then raised to 138 by the year of 2006, and again dropped down to 92 in 2007.

With regard to the share of the girls amongst detained minors, it also suffered important variations, recording both major escalations, and decreases. The maximum percentage of girls in the total of the detained minors was recorded in 2006 (14 of 138, or 10,1%), and the minimum in the immediately following year (4 of 92, or 4,3%).

9.23. Number of convicted persons in penitentiaries

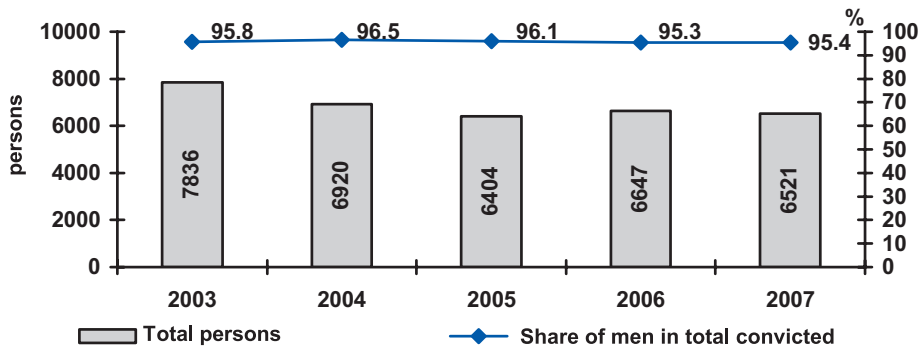

9.24. Convicted persons in penitentiaries, by sex and age group

	Total detainees				per 100 000 people			
	2006		2007		2006		2007	
	W	M	W	M	W	M	W	M
Total	312	6335	303	6218	17	368	16	361
including by age:								
under 20 years	67	872	34	762	32	435	17	386
20-29	93	2710	79	2629	28	838	25	844
30-39	73	1662	102	1677	31	679	43	687
40-49	52	755	48	727	21	266	19	259
50-60	22	278	35	352	11	114	16	139
over 60 years	5	58	5	71	3	21	3	25

As is the situation for the offenders, the women detained in penitentiaries are elder than men. The share of the age group 20-29 among female detained is much smaller than the share of the detained males of the same age (26,1% compared to 42,3%). This difference is numerically compensated in the age group 30-39 years, the share of which is 33,7% among women and 23,4% among men. If we go back to the distribution by age group of men and women who committed offences in 2007, we see that in the age groups 18–24 years and 25–29 years, women commit, de facto, less offences than men, thus the differences established in the age structure of the convicted cannot be explained by the fact that women receive less severe convictions because they more frequently take care of minor children.

9.25. Women in penitentiaries, by age group in 2006-2007

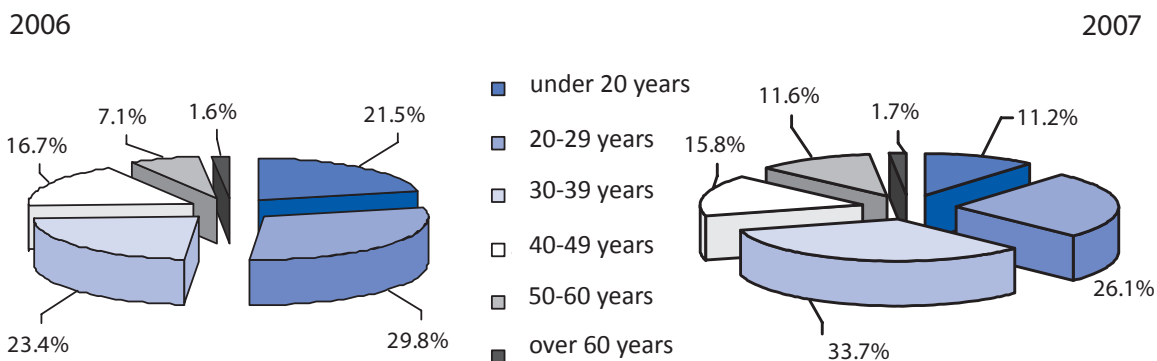

9.26. Men in penitentiaries, b0079 age group in 2006-2007

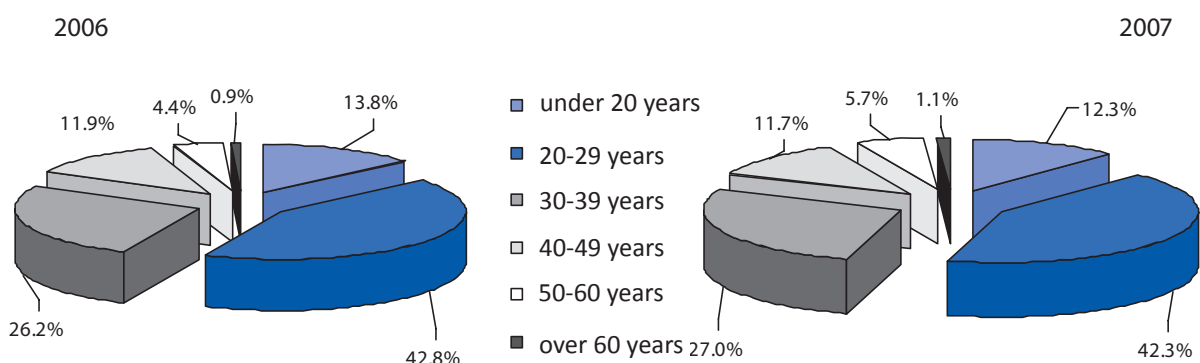

9.27. Foreign detainees in penitentiaries, by sex

	2006		2007	
	Total	% of total detainees	Total	% of total detainees
Total	119	1,8	107	1,6
Men	117	1,8	103	1,7
Women	2	0,6	4	1,3

In 2007 in the Moldovan penitentiaries, 107 foreign citizens were detained, this represents 1,6% of the total number of detained persons. Compared to 2006, their number reduced with 12 persons.

From the total number of foreign detained persons, 4 were females, or 1,3% of the total number of female detained. The share of the women in the total number of foreign detained is 3,7%, a little smaller than in the total number of detained in the same year (4,6%)

TRAFFICKED PERSONS

9.28. Trafficked persons

	2003		2004		2005		2006		2007	
	W	M	W	M	W	M	W	M	W	M
Total persons	225	16	354	57	314	78	338	30	371	38
Total minors	28	4	55	12	30	21	35	27	41	16
Total persons per 100 000 people	12	1	19	3	17	5	18	2	20	2
Total minors per 100 000 people	6	1	12	3	7	5	8	6	10	4

9.29. Trafficked persons

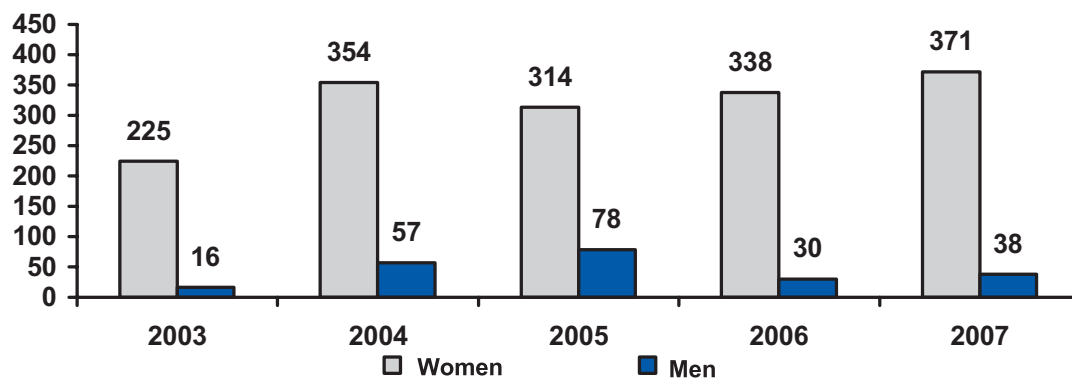

If criminality is predominantly a male phenomenon with regard to the number of offenders, the trafficking in human beings has a predominantly feminine nature. In 2007 a number of 409 cases of trafficking in human beings was recorded, of which 371 (91%) victims were females.

The evolution of the phenomenon was marked by different tendencies for women and men. If in 2003 it was registered the lowest rate for women (225) and for men (16 cases), the maximum level was reached in 2005 for men (78) and in 2007 for women (371).

9.30. Trafficked minors

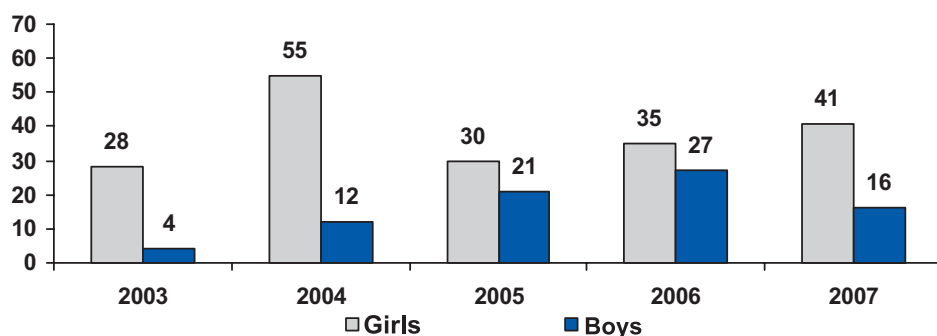

With regard to the frequency of the trafficking in minors, which is 57 cases in 2007, or 14% of the total number of cases, the evolution in the last five years was also discontinuous. On the other hand, the share of the boys among the trafficked minors is much higher than that of the men in the general number of trafficked persons. Thus, for instance, in 2006 the boys represented 44% from the total number of trafficked minors, 28% in 2007, while the maximum percentage of men among trafficked persons in total was recorded in 2005, when it was 20%.

9.31. Number of trafficked persons by age group

	2006						2007					
	Total		Urban		Rural		Total		Urban		Rural	
	W	M	W	M	W	M	W	M	W	M	W	M
Total cases	373	57	116	16	257	41	412	54	159	8	253	46
including for												
Prostitution												
14-15	10	6	2	1	8	5	8	2	2		6	2
16-17	20		6		14		13		5		8	
18-24	154		53		101		172		63		109	
25-29	53		14		39		99		54		45	
over 30	19		7		12		30		12		18	
Slavery												
14-15	2	12		5	2	7	9	8	3	1	6	7
16-17	3	8	1	2	2	6	11	6	3		8	6
18-24	38	10	10	3	28	7	4	4	1		3	4
25-29	45	8	15	1	30	7	19	12	9	3	10	9
over 30	29	13	8	4	21	9	47	22	7	4	40	18

The trafficking in human beings has different features, depending on the sex of the victim. The trafficking for sexual exploitation is the widest form of trafficking in women, but it is extremely rare in men, who, as a rule, are trafficked for slavery.

In terms of percentage, it comes out that in the case of women, the frequency of the trafficking does not depend on the area of residence (although the number may differ, women from urban area, trafficked in 2007 represent 39% from the total number of trafficked women, which is close to the general distribution of the population by area of residences), while men from rural areas are a lot more exposed to the risk of being trafficked. From the total number of male victims of trafficking in 2007, 85% are from rural areas.

The age structure of the victims depends on the form of trafficking. In the case of prostitution, the major share is for the age group 18–24 years, while in the case of forced labour trafficking, most part of the victims are aged above 25 years.

Violence against women – a wide spread phenomenon, but difficult to reflect in statistics

Violence against women is defined as ‘any act of violence based on the gender of the victim which results, or may result in physical, sexual or psychological injuries or sufferings on women, including the threatening to perform such acts, forced or arbitrary confinement, regardless of the fact if this act takes place in public or in private.’ This type of violence appears in every community. It includes rape, sexual abuse, sexual harassment, trafficking in women and forced prostitution.

Solid and trustworthy statistical data are needed in order to evaluate the amplitude of the phenomenon and to adopt policy measures for preventing and combating domestic violence. Given the delicacy of the matter and of the predominant culture, which tolerates domestic violence and which does not qualify it necessarily as a crime, women incline not to report the incidents, especially when these occur at home. Thus, the statistics based on reported cases underestimate strongly the level of violence. The general research of victims of violence, realized in Canada in 2004, shows that only one woman of three aggressed by the partners reported the incidence to the police.

Nevertheless, statistical data on the real frequency of the phenomenon are missing, but traditional sources can be used in order to collect data in reported cases:

- Police statistics – types of offences, information on the victims and their relationship with the aggressors
- Homicide statistics – information on victims and offenders and the relationship between them
- Court statistics – cases of violence against women, by type of violence, those in trial, solved and the sentences

Case study- National research on domestic and workplace violence, Romania 2003

In Romania, a non-governmental organization (Partnership for Equality Centre) implemented the first and the only research on domestic violence at national level.

The obtained statistical data show that only in 2003 a number of 827000 women were frequently subjected to different types of domestic violence:

- 739000 women were insulted, threatened or humiliated,
- more than 320000 women were physically abused and a similar number suffered abuses which lead to forced restriction of social relationships,
- over 193000 women did not have their personal money or were forcedly bereaved of money, by other members of the family, and
- over 70000 women were abused in multiple ways, including sexually;
- over 340000 children witnessed frequently cases of physical violence between parents;
- more than 370000 children witnessed frequent insults and expressions of strong language between parents or between adults in the household.

ROAD ACCIDENTS

9.33. Persons who suffered as a result of road accidents

	W	M	W	M	W	M	W	M
Total traumatised persons	1098	1789	1073	1698	1062	1745	1090	1895
Total deceased persons	95	311	97	294	92	290	120	344
Total traumatised persons per 100 000 people	58	104	57	98	57	101	59	110
Total deceased persons per 100 000 people	21	65	22	64	22	66	29	80

Following to road accidents, in 2007, a number of 1090 women and 1895 men were injured. The same caused the death of 120 women and 344 men. It was the year with the highest recorded level of trauma and deaths following to road accidents, after 2004.

The percentage of the death cases to the total number of persons who suffered following to accidents shows that men die more frequently than women, this leads to the fact that accidents involving men are more severe than the accidents involving women.

9.34. Persons who suffered as a result of road accidents

	Total						per 100 000 people					
	2006			2007			2006			2007		
	T	W	M	T	W	M	T	W	M	T	W	M
Total persons	3189	1154	2035	3449	1210	2239	89	62	118	96	65	130
including:												
traumatised	2807	1062	1745	2985	1090	1895	78	57	101	83	59	110
deceased	382	92	290	464	120	344	11	5	17	13	6	20
	including minors:											
Total minors	480	212	268	542	224	318	56	51	61	64	54	74
including												
traumatised	441	199	242	501	205	296	51	47	55	59	50	68
deceased	39	13	26	41	19	22	5	3	6	5	5	5

As a result of road accidents, in 2007 a number of 542 minors were injured, what represents almost 16% from the total number of victims.

The gender distribution of the deceased minors shows that the situation is different from the overall situation. Although girls represent a minority in the total number of minors injured following to road accidents (41,3%), girls decrease more frequently, they represent 46,3% of the total number of deceased minors, or 8,5% of the total number of girls who were injured in accidents, while in the case of the boys, the share of the deaths is only 6,9% of the total number of minor victims.

10. LIVING STANDARDS

10.1. Main characteristics of households by sex of household head

	2006				2007			
	Urban		Rural		Urban		Rural	
	W	M	W	M	W	M	W	M
Households composed of:								
1 person	35,3	8,0	46,3	9,0	32,3	9,6	45,0	10,4
2 persons	26,7	27,1	18,1	31,4	33,1	29,3	19,3	33,5
3 persons	20,7	30,2	15,0	20,8	19,2	26,7	17,5	20,0
4 persons	11,4	26,5	10,7	22,3	10,9	25,0	10,1	19,9
5 and more persons	5,8	8,2	9,9	16,5	4,4	9,3	8,1	16,2
Total	100,0	100,0	100,0	100,0	100,0	100,0	100,0	100,0
Type of household:								
one person	35,3	8,0	46,3	9,0	32,3	9,6	45,0	10,4
family couple without children	6,9	23,6	2,9	28,4	10,0	24,2	3,0	29,9
family couple with children	6,1	31,0	2,1	25,8	6,3	30,0	2,7	23,2
one parent with children	9,1	1,0	6,2	0,5	9,8	0,8	7,6	0,8
other households with children	20,0	16,1	28,7	21,4	17,4	16,9	27,1	19,6
other households without children	22,5	20,2	13,8	14,9	24,2	18,5	14,6	16,0
Total	100,0	100,0	100,0	100,0	100,0	100,0	100,0	100,0
Households raising:								
1 child	23,8	30,4	16,2	21,8	23,2	28,9	16,1	20,5
2 children	9,3	15,6	15,0	18,7	8,4	16,4	15,4	16,7
3 children	1,7	1,8	3,9	5,8	1,7	1,9	4,9	4,9
4 and more children	0,6	0,4	1,9	1,5	0,3	0,4	1,1	1,6
households without children	64,7	51,8	62,9	52,2	66,4	52,4	62,5	56,3
Total	100,0	100,0	100,0	100,0	100,0	100,0	100,0	100,0
Average size of household, persons	2.29	3.03	2.26	3.15	2.25	2.98	2.21	3.07
Average number of children under 18 years, per one household with children, persons	1,42	1,42	1,80	1,74	1,38	1,46	1,78	1,73

With regard to the size of household in 2006 the majority of households of the Republic of Moldova having women as heads of households were formed of a single person, both in urban areas (35,3%) and rural areas (46,3%). In rural areas this was also maintained in 2007, while in urban areas there is a slight inversion in the favour of households formed of 2 persons (33,1 % compared to 32,2%).

In case of households led by men, in 2006 there is a contrast between rural and urban areas considering the majority of households in the urban areas having men as heads of households were formed of 3 persons (30,2%), while in rural areas the majority of households were formed of 2 persons (31,4%). Regardless of their area of residence, in 2007 the majority of households led by men were formed of 2 persons.

Both in 2006 and 2007, according as the number of persons in a household increases, regardless of their area of residence, the number of households headed by men is higher than households led by women.

The most significant gender differences in terms of the type of household were noted in households formed of a single person and the households led by a single parent with children. Thus, in 2006 the households having women as heads of households were formed of a single person, both in urban areas (35%) and rural areas (46%). Both in urban (32,3%) and rural (45%) areas this was also maintained in 2007. One of the reasons of this situation is due to women's higher life expectancy, and many of them survive their husbands what means that many of these households are being headed by aged women.

Rather women than men are heads of households formed of a single parent with children: in 2006, in urban areas 9,1% of the households are led by women and 1% are led by men. There is still a difference in case of households in rural area: 6,2% of the households are led by women and 0,5% are led by men. This was also maintained in 2007 with a slight percentage increase: in urban areas 9.8% of the households are led by women and 0.8% are led by men and in rural areas 7.6% of those led by women compared to 0.8% led by men.

Over the years 2006 and 2007 the majority of households regardless of the sex of the household head and the area of residence had no children. The households that had only one child were ranked the 2nd, if expressed in percent.

10.2. Distribution of household members aged 15 and over by main source of income and sex

	2006				2007			
	Urban		Rural		Urban		Rural	
	W	M	W	M	W	M	W	M
Total household members	100,0	100,0	100,0	100,0	100,0	100,0	100,0	100,0
including those deriving income from:								
Individual agricultural activity	3,5	3,0	28,8	31,1	3,4	3,2	27,6	31,4
Remunerated agricultural activity	0,7	1,9	6,6	12,6	0,7	1,7	5,2	11,2
Self-employment, handicraft, freelance activity	4,9	9,1	1,5	4,8	3,7	7,2	1,0	4,0
Remunerated work in the state non-agricultural sector	16,7	15,8	11,7	6,8	15,9	13,5	11,9	6,5
Remunerated work in the private non-agricultural sector	25,2	33,7	6,8	10,9	25,2	34,1	8,0	11,8
Scholarships	0,7	0,5	0,7	0,5	1,5	1,3	0,7	0,6
Pensions	22,7	15,1	29,8	20,4	22,8	17,7	30,8	21,4
Social payments	3,6	0,4	2,8	1,0	4,8	1,2	3,0	1,1
Support	16,4	16,6	9,5	9,6	15,2	14,7	9,0	9,2
Remittances from abroad	3,6	2,1	1,5	2,1	4,6	3,9	2,5	2,6
Other source of income	1,9	1,9	0,1	0,2	2,1	1,4	0,2	0,2

Expectedly, the main source of income of the majority of households in urban areas, regardless of sex of the household head, is remunerated work in the non-agricultural sector (mostly in private non-agricultural sector and less in state-based sector), whilst in rural areas main source of income of the majority is individual agricultural activity. Even in rural areas the share of work paid for agricultural activities is rather low when considered a main source of income.

The pension is the second main source of income regardless of the sex of the household head and the area of residence. However, in case of households led by women, the share of households having pension as a main source of income is only approximately by 20% lower than the share of those having as a main source of income other lucrative activities.

Also, in case of households having social payments as a main source of income, their share is higher at the level of households headed by women than in case of those lead by men.

10.3. Distribution of household members aged 15 and over by main source of income and age group

percent

	15-18 years		19-29 years		30-39 years		40-49 years		50-59 years		60-69 years		70-79 years		>80 years	
	W	M	W	M	W	M	W	M	W	M	W	M	W	M	W	M
Total household members	100,0	100,0	100,0	100,0	100,0	100,0	100,0	100,0	100,0	100,0	100,0	100,0	100,0	100,0	100,0	100,0
including those deriving income from:																
Individual agricultural activity	5,8	6,3	17,4	19,8	22,1	24,1	18,6	28,4	18,0	25,5	5,7	11,0	5,6	10,2	2,3	6,3
Remunerated work in agricultural sector	1,8	1,2	3,2	2,7	5,6	6,5	4,5	10,8	5,8	10,4	0,4	2,0	-	0,5	-	-
Self-employment, handicraft, freelance activity	0,1	0,5	3,4	4,2	5,5	8,2	7,9	5,8	2,1	3,9	0,6	0,2	-	-	-	-
Remunerated work in the state non-agricultural sector	-	0,2	7,5	9,1	16,3	16,0	21,0	19,5	21,6	19,2	4,8	6,9	1,5	1,0	-	-
Remunerated work in the private non-agricultural sector	3,0	3,2	26,3	25,4	31,2	29,5	29,8	25,3	23,2	18,5	2,5	4,8	0,2	0,8	-	-

	15-18 years		19-29 years		30-39 years		40-49 years		50-59 years		60-69 years		70-79 years		>80 years	
	W	M	W	M	W	M	W	M	W	M	W	M	W	M	W	M
Scholarships	3,8	4,8	2,6	3,1	-	-	-	-	-	-	-	-	-	-	-	-
Pensions	7,1	1,4	0,9	0,2	2,7	1,8	7,1	4,5	22,7	17,9	85,8	75,0	91,5	87,1	97,7	92,6
Social payments	2,8	1,5	5,0	8,5	3,5	6,4	1,0	0,6	0,7	-	-	0,1	1,3	0,5	-	1,1
Support	68,8	78,4	19,8	20,2	3,1	2,9	3,0	1,7	2,4	2,3	0,3	-	-	-	-	-
Remittances from abroad	3,9	0,7	10,0	5,0	8,4	4,2	6,4	3,4	2,2	1,8	-	-	-	-	-	-
Other source of income	2,9	1,8	3,8	1,8	1,6	0,3	0,7	0,1	1,3	0,5	-	-	-	-	-	-

As regards the distribution of household members by age group and main source of income, the notable gender differences at the level of women by the retirement age, more women than men make a profit on work from private non-agricultural sector, while considerably much more men than women receive earnings from individual agricultural activities.

The majority of persons having as a main source of income money remitted from abroad are 19-29 year-old women.

It is interesting to notice that 8,5% of male members of households aged between 19 and 29 years have social payments as a main source of income. This could be explained by the unemployment rate for men within this age group which is higher than women's.

10.4. Structure of disposable income by sex of household head

	2006					
	Total		Urban		Rural	
	W	M	W	M	W	M
Disposable income (monthly average per capita, lei)	842,4	838,4	952,9	1026,5	737,5	718,8
including by source						
Income from employment	35,1	44,4	46,1	62,6	21,5	27,9
Income from individual agricultural activity	14,4	20,4	1,9	3,0	29,7	36,2
Income from individual non-agricultural activity	5,4	8,8	8,0	11,6	2,3	6,3
Income from property	0,1	0,2	0,2	0,4	0,1	0,03
Social benefits	16,6	11,7	15,3	9,8	18,3	13,4
Pensions	14,1	9,6	12,6	7,6	15,9	11,5
Child allowances	0,4	0,4	0,2	0,4	0,6	0,4
Compensations	0,6	0,5	0,5	0,4	0,8	0,6
Other income	28,4	14,4	28,5	12,6	28,1	16,1
of which remittances	22,3	10,2	21,3	7,1	23,6	13,0
	2007					
Disposable income (monthly average per capita, lei)	1067,3	993,7	1224,9	1200,1	911,5	865,3
including by source:						
Income from employment	37,0	43,8	49,7	60,6	20,3	29,3
Income from individual agricultural activity	11,3	17,3	1,2	2,5	24,6	30,0
Income from individual non-agricultural activity	5,7	6,7	7,9	8,7	2,9	5,1
Income from property	0,4	0,2	0,6	0,4	0,1	0,1
Social benefits	14,9	12,8	13,4	10,8	16,9	14,5
Pensions	13,1	10,6	11,8	8,5	14,8	12,4
Child allowances	0,3	0,5	0,2	0,7	0,4	0,4
Compensations	0,6	0,5	0,5	0,4	0,6	0,6
Other income	30,6	19,1	27,2	17,1	35,2	20,9
of which remittances	23,8	14,1	17,9	9,4	31,6	18,1

Both in 2006 and 2007 the majority of households in urban areas have lucrative activities as main source of income, whilst the households in rural areas have private agricultural activities as their main source of income. Another important share, irrespective of the area of residence, results from social payments. In this case the majority of them is made of pensions.

Concerning the notable gender differences, they are the following:

- At the level of all households, the ones headed by women have slightly higher disposable income than households headed by men;
- In 2006, the households headed by women in urban areas have a lower income than the households headed by men, whilst in rural areas the situation is reversed; in 2007, irrespective of the area of residence, households headed by women had a higher disposable income than households headed by men;
- More households headed by men compared to households headed by women have employment as a source of income;
- More households in rural areas headed by men compared to households headed by women have private agricultural activities as source of income.
- More households headed by women compared to households headed by men receive social payments, especially pensions, as source of income.

10.5. Structure of consumption expenditures by sex of household head

	Total		Urban		Rural	
	W	M	W	M	W	M
Consumption expenditures (monthly average per capita, lei)	978,9	942,1	1109,2	1096,1	855,2	844,3
including for:						
Food products	44,8	44,2	40,1	39,3	50,5	48,2
Alcoholic drinks, tobacco	2,3	3,0	1,8	2,2	2,8	3,6
Clothing, shoes	11,5	12,1	10,5	12,3	12,8	11,9
House maintenance	14,3	13,3	14,2	12,5	14,5	14,1
House amenities	5,2	4,4	6,3	4,1	3,9	4,6
Medical care and health	5,6	5,0	6,4	4,9	5,0	5,2
Transport	4,0	5,6	4,8	7,1	3,0	4,4
Communications	4,3	3,8	5,3	4,9	3,0	2,9
Entertainment	1,9	2,1	2,7	3,2	0,9	1,1
Education	0,3	0,5	0,4	0,9	0,1	0,2
Hotels, restaurants, cafeteria, etc.	2,1	2,8	3,0	4,5	0,9	1,4
Miscellaneous	3,7	3,2	4,6	4,1	2,6	2,5
	2007					
Consumption expenditures (monthly average per capita, lei)	1175,4	1090,1	1340,2	1281,0	1021,5	971,2
including for:						
Food products	43,8	43,9	40,9	41,3	47,6	45,9
Alcoholic drinks, tobacco	1,9	2,9	1,5	2,0	2,5	3,6
Clothing, shoes	12,3	11,8	11,5	11,3	13,4	12,2
House maintenance	13,8	13,4	12,5	11,8	15,5	14,6
House amenities	4,7	4,8	4,4	4,6	5,1	5,0
Medical care and health	5,2	5,6	5,6	5,8	4,7	5,4
Transport	4,8	5,0	6,5	6,1	2,5	4,1
Communications	4,5	4,1	5,0	4,9	3,9	3,4
Entertainment	2,0	2,2	2,8	3,0	1,1	1,5
Education	0,5	0,3	0,7	0,6	0,1	0,1
Hotels, restaurants, cafeteria, etc,	2,5	2,5	3,8	4,1	0,8	1,1
Miscellaneous	4,0	3,6	4,9	4,5	2,9	3,0

The households headed by women have slightly a higher consumption than the households headed by men. In 2007 the average difference was under 100 lei.

Although there is no notable gender differences, it could be noticed that women follow the trend to spend more on food stuffs, clothing & footwear, house maintenance and communications, while in case of men who spend more on alcoholic beverages & tobacco, house equipment, health care & health, transport and hotel accommodation, restaurants, cafeteria, etc.

While the majority of the above-mentioned fall under the general typology of gender attitudes, the fact that the households headed by men tend to have slightly higher expenditures for medical care and health (although the difference is insignificant) is beyond the typical gender attitudes.

10.6. Provision of households with amenities, by area

percent

	2006				2007			
	Urban		Rural		Urban		Rural	
	W	M	W	M	W	M	W	M
House amenities								
Electrical lighting	99,8	99,9	99,2	99,4	99,8	99,9	99,6	99,3
Water supply	82,5	84,0	10,3	12,8	84,1	80,6	10,0	14,8
Public hot water supply	30,8	29,2	0,6	0,2	25,3	22,3	0,1	-
Central heating	50,2	42,1	0,9	0,6	47,9	39,8	1,0	0,4
Own/autonomous heating system	23,9	31,6	3,6	6,6	27,7	29,9	4,2	5,2
Bathroom-and-toilet	73,9	70,1	3,3	3,7	76,8	69,3	3,2	3,5
Sewerage system	83,8	84,7	11,0	13,3	85,6	82,1	10,7	15,2
Bathroom or shower	73,9	77,00	8,0	10,4	78,0	75,5	7,7	12,0
Telephone	87,4	91,3	52,8	67,8	90,1	92,8	61,4	74,6

As concerns the existing amenities in the house, almost every household has electric lighting, irrespective of the household head's area of residence and sex. The differences become visible at the level of other facilities, namely regarding urban or rural area of residence. The weighted majority of households in urban areas have water supply, sewage, toilet and bath, bathtub or shower and telephone or central heating. The households in rural areas unsatisfactorily have the majority of facilities. The percentage shows below 1 at the level of hot water and central heating supplies, as expected in the areas where no blocks of flats exist. Regarding the other facilities, there are still essential differences between urban and rural areas, and at the rural area level, households headed by women are less provided with facilities than households headed by men.

10.7. Provision of households with durable goods, by area

units per 100 households

	2006				2007			
	Urban		Rural		Urban		Rural	
	W	M	W	M	W	M	W	M
Camera	24,8	37,2	12,5	16,6	18,7	32,3	11,9	14,1
Television set	87,5	90,4	57,9	72,7	94,1	97,7	82,9	90,4
Tape recorder	22,7	29,9	20,8	28,2	16,9	21,3	16,7	19,3
Computer	11,6	19,5	1,8	2,8	13,7	19,9	3,2	3,2
Refrigerator	91,4	91,9	62,4	70,8	88,9	93,4	62,9	73,7
Microwave oven	6,2	10,8	3,1	4,0	7,0	9,5	3,5	4,4
Mechanical washing machine	35,2	33,9	34,3	45,1	30,4	28,8	33,8	43,1
Automated washing machine	27,8	39,7	3,0	6,3	34,4	45,7	3,9	6,5
Vacuum cleaner	59,0	67,3	17,1	26,8	54,4	66,7	20,4	26,4
Bicycle	6,3	12,9	12,1	20,9	5,5	10,9	9,8	19,0
Car	8,6	27,5	7,0	18,6	9,2	26,8	8,3	17,8

With regard to durable goods, generally less of the households led by women possess such goods compared to households led by men. The biggest differences in rural areas are in terms of computers, microwaves, automatic washing machines, and transportation means (bicycles and cars).

10.8. Assessment of the standard of living, by area

	2006				2007			
	Urban		Rural		Urban		Rural	
	W	M	W	M	W	M	W	M
How do you assess your household's living standards?								
Very good or good	12,5	18,5	10,2	16,4	9,7	13,5	11,1	12,7
Satisfactory	52,6	59,8	62,5	64,6	55,6	66,6	63,4	68,0
Bad	29,9	19,7	24,6	17,5	31,2	18,2	23,1	18,0
Very bad	5,0	2,0	2,8	1,5	3,5	1,8	2,4	1,3
Total	100,0	100,0	100,0	100,0	100,0	100,0	100,0	100,0
How do you assess your household's living standards, as compared to previous year?								
Better	13,1	15,0	10,7	14,9	14,2	15,8	12,0	11,7
The same	53,1	56,7	61,5	61,0	52,7	59,2	57,7	57,2
Worse	33,8	28,3	27,8	24,0	33,1	25,0	30,4	31,0
Total	100,0	100,0	100,0	100,0	100,0	100,0	100,0	100,0

In 2006 as well as in 2007 more male household heads than female household heads consider the standard of living of their own household as very good or good compared to women's, regardless of the area of residence. In 2007 the number of household heads considering so the standard of living is decreasing.

In the same way, at the level of both years more female household heads than men regardless of the area of residence, considers its standard of living as worse. In 2007, at the urban level, the gender difference at the respective level of appraisal shows 13 percent.

The majority of people consider standard of living as the same, while 8% of female household heads more than men in 2007 consider the standard of living of their households worse as compared to the previous year.

10.9. Poverty rate, by area of residence and household size, 2006-2007

	2006			2007		
	T	W	M	T	W	M
Total	30,2	31,8	29,4	25,8	25,7	25,9
Urban	24,8	28,9	22,5	18,4	21,2	16,5
Rural	34,1	34,7	33,8	31,3	30,2	31,7
Total						
Household size, persons						
1	29,6	29,4	30,3	25,8	26,1	24,9
2	24,9	23,3	25,6	23,8	21,8	25,0
3	21,8	22,6	21,5	17,4	19,3	16,3
4	28,4	38,7	25,6	23,7	28,9	22,0
5+	46,0	47,0	45,6	39,5	37,5	40,2
Urban						
Household size, persons						
1	24,1	23,9	24,6	19,6	18,9	21,6
2	24,3	25,0	23,8	19,7	20,0	19,3
3	18,9	22,8	16,9	12,3	17,2	9,2
4	21,3	32,3	17,9	15,9	25,1	12,3
5+	44,6	47,3	43,1	31,4	29,2	32,3
Rural						
Household size, persons						
1	33,4	33,3	33,7	29,9	31,1	26,9
2	25,3	20,9	26,6	27,3	24,9	28,1
3	24,9	22,3	25,8	22,1	21,5	22,4
4	34,3	45,1	31,7	30,5	32,8	29,8
5+	46,5	46,9	46,3	42,7	42,0	42,9

10.10. Poverty rate by type of household, 2006-2007

	2006			2007		
	T	W	M	T	W	M
Number of children in the household						
1	25,1	23,8	25,6	22,9	22,6	23,0
2	31,7	34,8	30,6	26,1	24,8	26,6
3	47,6	45,0	48,6	39,4	40,4	38,8
4+	65,4	69,8	62,6	53,2	42,5	57,5
households without children	27,2	30,1	25,8	23,8	24,8	23,2
Type of household						
one person	29,6	29,4	30,3	25,8	26,1	24,9
family couple without children	25,7	20,2	26,3	26,1	28,0	25,8
family couple with children	29,0	32,1	28,8	22,1	19,1	22,4
one parent with children	27,1	29,4	11,8	21,9	23,1	12,1
other households with children	34,9	34,1	35,4	31,6	28,7	33,6
other households without children	27,3	32,7	24,5	21,3	23,0	20,2

With regard to the total poverty rate, a slight decrease was registered in 2007 as compared to 2006. Nevertheless, in 2006 the poverty rate among women was higher than among men, both in urban and in rural areas. Though in 2007, in urban areas a (decreased) level of gender difference is kept, in rural areas the poverty rates for women and men were approximately equal.

As expected, depending on the size of the household, the highest poverty incidence is among households with 5 or more persons. If over 2006 the poverty rate of households with 5 or more persons headed by women had a higher poverty rate than that of men, in 2007 the situation is reversed. There is a visible decrease in the poverty rate within this type of households in 2007 compared to 2006.

This condition is valid for households with 4 or more children, where the poverty rate in 2006 was over 60%, in case of women reaching almost 70%. In 2007 it decreased considerably, with regard to households headed by women showing the highest improvement: poverty rate reduced with 27,3 percentage points.

11. INTERNATIONAL STATISTICS

The countries selected for comparison in this chapter were divided into 2 categories:

- countries in the vicinity of the Republic of Moldova (Belarus, Russian Federation, Ukraine);
- EU Member States:
 - 3 of the so-called Old Member States with indicators to which the Republic of Moldova aspires, such as Germany, or which have some similarities in terms of public thinking, such as Italy and Portugal,
 - 3 of the so-called New Member States (Bulgaria and Romania, the newest member states, as well as Lithuania, due to common historical developments in the ex-Soviet area).

11.1. Population by selected age groups (% of total), 2005

	0-14		15-64		65+	
	W	M	W	M	W	M
Republic of Moldova*	8,7	9,1	36,8	35,0	6,4	3,9
Belarus*	7,2	7,6	36,2	34,3	9,9	4,8
Bulgaria	6,7	7,1	34,7	34,3	10	7,1
Russian Federation*	7,2	7,5	37	34,3	9,5	4,5
Germany	7	7,4	33	33,9	11	7,6
Italy	6,9	7,3	33,2	33,2	11,4	8,1
Lithuania	8,3	8,8	35,1	32,7	9,9	5,2
Portugal	7,6	8	34,1	33,2	9,9	7,1
Romania	7,7	8,1	34,9	34,6	8,6	6
Ukraine*	6,9	7,3	36,1	33,3	10,8	5,5

*in 2007

With regard to population, in general, the Republic of Moldova has the same characteristics with all the states selected for comparison in terms of age groups of 0-14 years and 15-64 years. However, it has the lowest percentage of the population over 65 years (both women and men). This can be interpreted in 2 ways: on the one hand, one could say that the rate of aging of the population of Moldova is lower than in other countries; on the other hand, however, it can be concluded that the Republic of Moldova has the lowest life expectancy of the countries under comparison.

11.2. Live births by sex (% of total), 2005

	W	M
Republic of Moldova	48,6	51,4
Belarus		
Bulgaria	48,7	51,3
Russian Federation	48,6	51,4
Germany	48,7	51,3
Italy	48,4	51,6
Lithuania	48,9	51,1
Portugal	48,3	51,7
Romania	48,5	51,5
Ukraine*	48,5	51,5

* in 2004

11.3. Infant mortality rate, 2005

per 1000 live births

	W	M
Republic of Moldova	12,7	12,1
Belarus	5,2	7,4
Bulgaria	9,0	11,8
Russian Federation	9,0	13,0
Germany	3,5	4,4
Italy	3,7	4,1
Lithuania	6,0	7,7
Portugal	3,5	3,5
Romania	13,0	16,8
Ukraine	8,7	11,2

In 2005, only Romania had an infant mortality rate higher than that of the Republic of Moldova, the Russian Federation had a higher infant mortality rate only for boys.

11.4. Infant mortality rate, 2005

(deceased aged under 1 year per 1000 live births) (%)

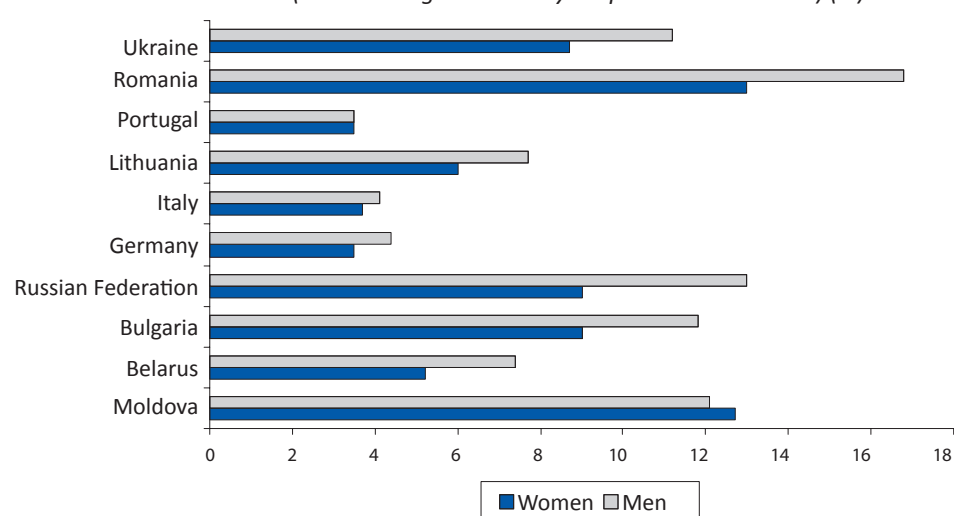

11.5. Mortality rate for children aged 1-4 years, 2005

Per 1000 inhabitants

	W	M
Republic of Moldova	0,71	0,98
Belarus		
Bulgaria	0,45	0,66
Russian Federation	0,7	0,8
Germany	0,18	0,22
Italy	0,18	0,19
Lithuania	0,27	0,56
Portugal	0,14	0,27
Romania	0,59	0,72

In 2005, Republic of Moldova had the highest mortality rate for children aged 1-4 years of all countries under comparison, being followed closely by Romania.

11.6. Total fertility rate

	2005	2006
Republic of Moldova	1,22	1,23
Belarus	1,21	1,29
Bulgaria	1,31	1,37
Russian Federation	1,29	
Germany	1,34	1,32
Italy	1,32	1,32
Lithuania	1,27	1,31
Portugal	1,4	1,35
Romania	1,32	1,31
Ukraine	1,2	1,3

Total fertility rate for both 2005 and 2006 is comparable to that of other states, although it is the lowest in absolute terms.

11.7. Life expectancy at birth, 2005

	W	M
Republic of Moldova	71,7	63,8
Belarus	75,1	62,9
Bulgaria	76,3	69,0
Russian Federation	72,4	58,9
Germany	81,8	76,2
Italy	83,2	77,6
Lithuania	77,4	65,4
Portugal	81,4	74,9
Romania	75,4	68,2
Ukraine	74,1	62,4

11.8. Life expectancy at birth by sex, 2005

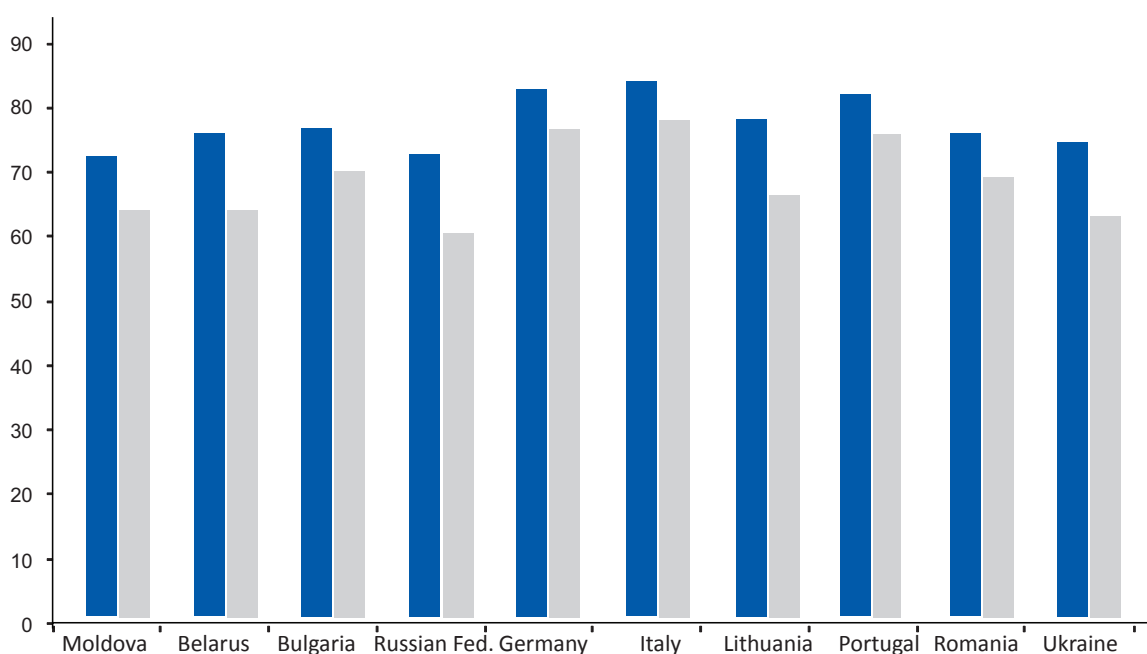

In 2005, life expectancy at birth for women in the Republic of Moldova, was the lowest among the reviewed countries (11,5 years less than for women in Italy) and third from last for men (13,8 years less than for men in Italy). Only the Russian Federation had a lower life expectancy for men (58,9 years versus 63,8 years).

11.9. Percentage of women in national parliaments, 2007

	Percent
Republic of Moldova	22
Belarus	29
Bulgaria	22
Russian Federation	10
Germany	32
Italy	17
Lithuania	25
Portugal	21
Romania	11
Ukraine	9

As regards the political participation of women, the percentage of 22% of women members of the national parliament, ranks the Republic of Moldova 4th in the top of the best percentages among countries under comparison (32% after Germany, 29% after Belarus and 25% after Lithuania, and at the same level with Bulgaria).

11.10. Labour force participation rate in some selected countries

%

Country	2005		2006	
	W	M	W	M
Republic of Moldova	47,7	50,4	43	50
Bulgaria	44,4	55,4	46,3	56,7
Russian Federation (15-72)	54,6	67,4	55,4	67,9
Germany	51,9	66,2	52,5	66,3
Italy	37,9	61,2	38,1	61
Lithuania	51,2	63,1	50,9	61,8
Portugal	55,6	69,4	55,8	69,7
Romania	46,9	61,5	47,8	62,6
Ukraine (15-70)	57	67,9	57,1	68,9

In 2005, the Republic of Moldova ranked 5th among countries under comparison in terms of female labour force participation rate, slightly ahead of Romania and almost 10% ahead of Italy. In 2006 the female labour force participation rate fell by almost 5%, while in most other countries it increased. A possible explanation of this phenomenon is legal or illegal labour migration.

11.11. Employment rate in some selected countries

%

Country	2005		2006	
	W	M	W	M
Republic of Moldova	44,8	46	40,5	45,5
Bulgaria	42	51,8	41,6	51,8
Russian Federation (15-72)	51,6	62,7	50,8	62,6
Germany	46,3	58,6	47,2	59,6
Italy	34,1	57,4	34,8	57,7
Lithuania	46,9	57,9	48,1	58,2
Portugal	50,8	64,8	50,8	65,1
Romania	43,9	56,7	44,9	57,5
Ukraine (15-70)	53,1	62,8	53,7	64,3

Women's employment rate in 2005 ranked the Republic of Moldova 6th among countries under comparison, also ahead of Romania, Bulgaria and Italy, while in 2006 employment rate decreased.

11.12. Unemployment rate in some selected countries

%

Country	2005		2006	
	W	M	W	M
Republic of Moldova	6	8,7	5,7	8,9
Bulgaria	9,8	7,6	9	8,6
Russian Federation (15-72)	6,8	7,5	7	7,3
Germany	10,7	11,4	10,1	10,3
Italy	10,1	6,2	8,8	5,4
Lithuania	8,3	8,2	5,4	5,8
Portugal	8,7	6,7	9	6,5
Romania	6,4	7,8	6,1	8,2
Ukraine (15-70)	6,8	7,5	6	6,7

In terms of unemployment, the unemployment rate was lower in 2006 than in 2005 in all countries under comparison, except Portugal. In 2006 the Republic of Moldova had the lowest unemployment rate among women (6%), in 2007 it was preceded only by Lithuania, which managed only in 1 year to decrease the unemployment rate among women almost by half.

GLOSSARY OF TERMS

POPULATION AND NATURAL MOVEMENT OF POPULATION

Rank of the live-born child	refers to the numeric order of a live-born child as a ratio of the total number of live-born children of a mother.
Cause of death	disease, morbid state or „accidental” or „voluntary” traumatism and poisonings that contributed or provoked death. The causes of death are in accordance with the international classification of the World Health Organization – Revision 10.
Natural increase	is the difference between the number of live-born persons and the number of deceased persons, in the reference year.
Birth rate	is the number of the live-born persons in one year as a ratio of the average annual number of population and is expressed as the number of births per 1000 inhabitants.
General fertility rate	is the number of the live-born persons in one year as a ratio of the average annual number of female population of 15-49 years of age and is expressed in the number of live births per 1000 women of fertile age (15-49).
Total fertility rate	is the average number of children, which a woman could give birth to during her fertile life, subject to the fertility of the respective year.
Mortality rate	is the number of persons who died in one year as a ratio of the average annual number of population and is expressed in the number of deaths per 1000 inhabitants.
Life expectancy at birth	is the average number of years a newborn child is expected to live, if he/she would live the rest of life, subject to mortality by age in the reference period
Life expectancy at certain ages	is the average number of years that a person of a certain age (x) is expected to live if he/she would live the rest of life, subject to mortality by age in the reference period.
Marriage rate	is the number of marriages in one year as a ratio of the annual average number of the population and is expressed in number of marriages per 1000 inhabitants.
Divorce rate	is the number of divorces in one year as a ratio of the annual average number of the population and is expressed in number of divorces per 1000 inhabitants.
Distribution of demographic events by territorial profile (by rayon)	was made according to the following criteria: <ul style="list-style-type: none">- live-born children – by mothers’ domicile;- deceased – by the domicile of the deceased person;- marriages – by the place of marriage registration;- divorces – by the place of divorce registration;
Rates by rayon and area of residence	are calculated as a ratio of the average number of stable population of the respective rayon.

HEALTH CARE

Morbidity of population	is characterized by the number of patients detected (or taken under supervision by the outpatient unit) during the year, at their appeal to the treatment and prophylactic institution or during prophylactic examination.
Primary morbidity	is registered while defining the diagnosis of the sick person for the first time in his/her life.
General morbidity	of population is the total number of sick persons registered during the year. Here evidence is taken of sick persons with the diagnosis determined for the first time, and of persons who repeatedly addressed with the respective disease.
Morbidity rate	is determined as the ratio between the number of sick persons and the average annual number of population. For statistical processing of data on the morbidity of population is applied the international Classification of diseases and of health problems, revision X, which ensures comparability of information on morbidity and mortality.
Contingent of sick persons	includes the totality of sick persons of a certain disease, who have addressed to medical institutions both during the current year, as well as during the precedent years. The indicators are calculated as the ratio between the number of sick persons at evidence at health care institutions at the end of year and the number of population at the end of year.
Disability	is qualified as worsening of the state of health, accompanied by stable disturbance of the functions of the organism, conditioned by diseases, consequences of traumas or infirmity, which lead to vital activity limitation of the person and to the necessity of social protection of the person.
Primary recognition of disability	is the definition of disability degree for the first time in the reported year.

MIGRATION

International migration	is the change of domicile to another country or, from another country to the Republic of Moldova.
--------------------------------	---

LABOUR MARKET

Economically active population (or labour force)	comprises all persons who supply labour force for the production of goods and services during a reference period, including the employed and the unemployed population .
Dividing people by categories	as participation in economic activity, is made in accordance with the principle of priority of employment to the unemployed and the unemployment towards inactivity.

Activity rate	the ratio between the working population aged 15 and over and the total population of the same age group, expressed as a percentage.
Employed population	<p>in accordance with the <i>Labour Force Survey methodology</i>, a person is considered that he/she worked if that person during the 7 days of the reference week, and namely the week before interview, Monday through Sunday inclusively, carried out, on a regular basis or exceptionally, an occasional economic or social activity generating goods or services, was it for one hour only, in order to obtain income in the form of wages, in kind payment or other benefits, even if they were not collected during the same week.</p> <p>Under this definition, the following categories of persons are also considered as persons that <i>worked</i>:</p> <ul style="list-style-type: none"> · all individual farmers or members of companies or agricultural associations, even if they have not turned to account the products for which they have worked during the past week, but used it to their own consumption; · re-employed pensioners or those who have provided an occasional activity; · people who help a family member or a relative, on agricultural land, in the shop, farm or enterprise, if they have not done it exclusively from charitable purposes; · members of consumption and production cooperatives; · apprentices and paid employees on probation; · occasional or seasonal employees if they worked during the last week; · those self-employed workers who have not held regular activities for lack of orders or customers, but: <ul style="list-style-type: none"> • whether they have devoted time to those activities (<i>for example, an architect who has spent his time in office, waiting for customers, a driver who has repaired the truck</i>), • whether they were busy improving a new business or renovating the existing (e.g., purchase or installation of new equipment, ordering supplies for the pursuit of business, arranging construction of annexes); · those who said they had worked during the week of reference, even if they were at the same time, pupils, students and pensioners. · those who in the reference week said that were technically unemployed or on unpaid leave or who were on leave for childcare and were sure that they will return to work in less than 3 months. · seasonal employees who receive pay off season and ensure that they return to work in less than 6 months.
Employment rate	Ratio between the employed population aged 15 years and over and the total population of the same age group, expressed in percent.
Economic activities	<p>Proportion of employed population of age of 15 and above distributed on the three sectors of activity, expressed in percent:</p> <ul style="list-style-type: none"> - primary: agriculture, forestry, fishery; - secondary: industry (extractive, processing, electric and thermal energy, gas and water) and constructions; - tertiary: commercial services (trade, hotels and restaurants, transport, storing and communications, financial intermediaries, real estate transactions etc.) and social services (public administration and defence, education, health and social assistance, personal services etc.).
Type of production units	<p>is defined in accordance with the National Accounts System. The three sectors are:</p> <ul style="list-style-type: none"> - Production units of the <i>Formal Sector</i>; - Production Units of the <i>Informal Sector</i>; - <i>Households</i> Sector.

Employment in the Formal Sector	is defined as employment in: <ul style="list-style-type: none"> - Corporative enterprises, organizations and institutions (economic units with legal person right) or - Non-corporative enterprises, which are registered.
Employment in the Informal Sector	includes all persons which, indifferent of their professional status, during the reference period were employed by enterprises that pertain to the <i>informal sector</i> , having this occupation (employment) in their main or secondary activity. The enterprises of the informal sector are defined as non-corporative enterprises (without legal status), which are not registered.
Employment in households	includes persons employed in production of agricultural products in exclusivity for the consumption of the household, if they are employed in this activity 20 hours and more in the reference period, as well as household workers hired by the household.
Type (nature) of the job	can be <i>formal</i> or <i>informal</i> .
Formal employment	includes: <ul style="list-style-type: none"> - Self-employed employees who work at formal sector's enterprises; - Employers who work at the formal sector's enterprises; - Members of formal production cooperatives; - Employees, for whom the employer pays social contributions and who benefit from annual paid leave, from medical sick leave.
Informal employment	includes: <ol style="list-style-type: none"> 1) Self-employed employees who work at informal sector enterprises; 2) Employers who work at the informal sector enterprises; 3) Members of informal production cooperatives; 4) Family helpers hired at formal sector enterprises or at the informal sector enterprises; 5) Employees hired at the formal sector enterprises, at the informal sector enterprises or in private households of citizens, who satisfy at least one of the below criteria: <ul style="list-style-type: none"> - the employer does not pay social contributions for them; - does not benefit from annually paid leave; - does not benefit, in case of disease, by medical paid leave. 6) Persons dealing with production of agricultural products in households, in exclusivity for own consumption, with the work week duration of 20 hours and more.
Groups of occupations	represents the rate of employed people aged 15 years and over by groups of occupations, expressed as a percentage. Groups of occupations representing major groups of occupations under the Classification of Occupations in Moldova, adjusted to international classifier (ISCO-88, ILO): <ol style="list-style-type: none"> 1. Managers of public authorities at all levels, leaders and senior officials from socio-economic and political units 2. Highly skilled specialists 3. Medium skilled specialists 4. Administrative officials 5. Service workers, housing management and communal services, trade and related workers 6. Skilled workers in agriculture, forestry, hunting, fishery and fishing 7. Workers in large and small industrial enterprises, artisan handicrafts, construction, transport, telecommunications, geology and geological prospecting 8. Other occupations 9. Of which: unskilled workers

Employment status	<p>The ratio of employed aged 15 and over by professional status, expressed in percent. Employment status is divided into two categories:</p> <ul style="list-style-type: none"> - employees; - non-employees: employers, self-employed workers, unpaid family workers, members of cooperatives.
Employee	<p>is a person who performs his/her activity under a labour contract in an economic or social unit, irrespective of its form of ownership, or for private persons (based on a contract or an agreement), in exchange of a remuneration, such as wage, salary, in cash or in kind, fee etc. Military people on duty are registered under the same status.</p>
Employer	<p>is a person who practices his/her occupation (profession) in his/her own unit (company, agency, workshop, shop, office, farm etc.) for the activity of which he/she has employed one or more full-time employees.</p>
Self-employed worker	<p>is a person who performs his/her activity in his/her own unit or business, without employing any full-time employee, being helped or not by unpaid family members. Independent entrepreneurs (street vendors, tutors, private taxi-drivers etc.), free lance people (musicians, plastic artists, lawyers), occasional day-workers and individual farmers are also registered under this status. Self-employed workers may have part-time employees.</p>
Unpaid family worker	<p>is a person who performs his/her activity in a family economic unit managed by a family-member or a relative, for which he/she does not get any remuneration as salary or payment in kind. A farm is considered such a unit. If more people in a household work in their own agricultural household, one of them – usually, the head of household – is considered a self-employed worker, while others - unpaid family workers.</p>
Unemployed as defined by the ILO classification	<p>are the persons aged 15 years and over who during the reference period simultaneously meet the following conditions:</p> <ul style="list-style-type: none"> - have no work and do not perform any activity in order to earn any incomes; - have been looking for work, using in the last 4 weeks various methods to find a job: registration with the labour force units or private employment agencies, actions aimed at starting an own business, publication of announcements and replies to announcements, addressing friends, relatives, colleagues, trade unions etc.; - are available to start work in the next 15 days, if immediate employment can be found. <p>This category of population also includes:</p> <ul style="list-style-type: none"> - persons not working, available to work, waiting to be recalled to work or who have found work and will begin working at a date subsequent to the reference period; - persons who usually are referred to the inactive population (pupils, students, retired persons), but who have indicated that they are in search of work and are available to work.
Unemployment rate	<p>the ratio between the number of unemployed as defined by the International Labour Office (ILO) classification and the total active population, expressed in percent.</p>
Long-term unemployment	<p>when the unemployed person does not work and is seeking for a job for a year and more.</p>

Long-term unemployment rate	the ratio between the number of the ILO unemployed for 12 and more months and active population, expressed in percent.
Unemployment among young people	<ul style="list-style-type: none"> - the number of ILO unemployed (aged 15-24) and the total number of active population in that age group, expressed in percent - the ratio between the youth unemployment rate and the adult unemployment rate; - the share of unemployed youth in total unemployment; - the share of unemployed youth in total unemployed people aged 15-24.
Long-term unemployment among young people	the situation when young people aged (15–24 years) have no job and seek for it for 6 months and more.
Incidence of long-term unemployment among young people	ratio between the ILO unemployed aged 15-24 years who are unemployed for 6 months and more and the number of unemployed in the same age group (15-24 years), expressed in percent.
Registered unemployed	persons able to work, of labour age, who have no work, no other legal income and are registered at the employment agencies as persons in search of work and who prove that they want to be employed.
Economically inactive population	<p>comprises all persons, regardless of their age, who did not work at least one hour and who were not unemployed during the reference period.</p> <p>Economically inactive population includes the following categories of population:</p> <ul style="list-style-type: none"> - pupils or students; - retired people (of all categories); - housekeepers (who carry out only housekeeping activities in the household); - persons maintained by other persons or by the state, or who earn their leaving from other income (rents, interests, etc.); - persons reported as left abroad for work or in search of work.
Structure of population by level of education	<p>The level of education is grouped into:</p> <ul style="list-style-type: none"> - <i>low</i>: secondary, primary, without primary school; - <i>medium</i>: school, general secondary, vocational secondary , specialized secondary ; - <i>high</i>: university, post-university.

EDUCATION

Gross enrolment rate	in an educational level (preschool/primary/gymnasium) is the total number of children/pupils involved in that specific level of education, irrespective of age, as percentage ratio of the total population of official age corresponding to that very level of education (in a certain year of study).
Net enrolment rate	in an educational level (primary/gymnasium) represents the number of pupils of official age corresponding to this very level of education, involved in this specific level of education, as percentage ratio of the total population of official age corresponding to this very level of education (in a certain year of study).

Enrolled	in educational institutions (in accordance with the situation at the beginning of the year of study, for the current year of study) – persons admitted to the 1 st year for the first time.
Graduates	of educational institutions (in accordance with the situation at the beginning of the year of study, for the precedent year of study) – persons who were promoted successfully in the last year of study.
Branch group	is assigned to the educational institution, based on the profile of the majority of specialties.
Researchers	are specialists who perform research-and-development activity. Researchers-doctors and Researchers-doctors habilitat – researchers with scientific degree, respectively, doctors of sciences and doctor habilitat.

SOCIAL PROTECTION

The number of retired people	includes persons, whose pensions were established in accordance with the Law of the Republic of Moldova on pensions.
Average size of monthly pension	is calculated as the ratio between the total amount of monthly defined pensions and the number of beneficiaries of pensions.
Allowance	type of monetary support that is defined and granted through the public system of social assistance.
Asylum	social assistance institution providing support to elderly persons.
Guardianship	legal action aimed at protecting the interests of a minor.

CRIMINALITY

Registered offence	socially dangerous action, detected and officially taken on record by law enforcement bodies, in accordance with the penal legislation.
Violence (generic meaning)	is use of force and coercion by an individual, group or social class, in order to impose one's own will to other people.
Victim	person, adult or child, subjected to acts of violence in family, in concubinage.
Serious intentional damage of bodily or health integrity	action which is dangerous for life or which provoked loss of sight, hearing, voice or of any other organ or its functioning seizure, a psychological disease or other damage to health, accompanied by stable loss of at least one third of work capacity, or which led to pregnancy interruption or to irremediable transfiguration of the face and/or of adjacent areas.
Medium intentional damage of bodily or health integrity	action which is not dangerous for life and did not provoke severe outcome, but which was followed either by lengthy disturbance of health, or by a considerable and stable loss of less than one third of work capacity.

<i>Murder</i>	deprivation of a person from his/her life.
<i>Human trafficking</i>	action of recruitment, transportation, sheltering or reception of a person aimed at commercial or non-commercial sexual exploitation, through labour or forced services, in slavery, for use in armed conflicts or in criminal activities, for extraction of organs or tissue for transplantation.
<i>Detainee</i>	person kept under the state of arrest

LIVING STANDARDS

<i>Household</i>	as observation unit, is defined as a group of persons, not necessarily related, living at the same address with common house-keeping and budget or one person living separately, keeping the house alone and not belonging to other households.
<i>Household with children</i>	is a household comprising children under the age of 18 inclusively.
<i>Income and expenditure of population</i>	are expressed in the current prices of the reference period and the trends presented are not correlated with the mean consumption price index. The absolute values of income and expenditure represent mean values per household member being calculated by dividing the total income/expenditure of the collectivity to the number of persons living in this collectivity.
<i>Disposable income</i>	is defined as the totality of cash and in-kind incomes received from employment and self-employment, various social benefits, sales of agricultural production from plots, property income, other current transfers (including goods received as a gift and gratuities).
<i>Consumption expenditures</i>	include cash and in-kind expenditure for consumption needs of the household: consumption of food products, purchase of non-food items and payment of services.
<i>Poverty rate</i>	is the share of people with monthly expenditures per adult equivalent lower than the value of the absolute poverty line, of the total population. The method used to set the poverty line is referred to as the „basic needs cost” methodology.

